

GERDA[®]

PREMIUM DOOR MANUFACTURER



HOUSE DOORS

THERMO PRIME | THERMO PREMIUM | OPTIMA

TABLE OF CONTENTS



STEP BY STEP TO YOUR NEW EXTERIOR DOOR

TEDEE POWERED BY GERDA	3
READILY AVAILABLE DOORS	4
WHAT SHOULD YOU KNOW ABOUT GERDA DOORS	8
WHAT SHOULD YOU REMEMBER WHEN SELECTING GERDA DOORS	9
GERDA THERMO PRIME 75	12-13
GERDA THERMO PREMIUM 75	14-15
GERDA THERMO PREMIUM 60	16-17
GERDA OPTIMA 60	20-21
GERDA OPTIMA 50	22-23
AIR GLASS DOORS	26-31
QUADRO DOORS	32-53
ELITE 3D DOORS	54-55
TEMPO DOORS	56-75
CLASSIC DOORS	76-85
OPTIMA 60 DUO DOOR	86-87
ALUMINUM ILLUMINATORS	88-89
COLORS	90-91
ACCESSORIES SET	92-93
OPTIONAL EQUIPMENT	94-99
DOOR AND DOOR FRAME SIZES	100-105

TURN YOUR SMARTPHONE INTO A SMART DOOR LOCK



OPEN DOORS WITH YOUR SMARTPHONE

Open and close doors and monitor door lock status from any place around the world. With the automatic opening feature, you don't need to take your phone out from your purse or pocket. The lock will detect your presence and let you in. The self-locking feature works based on the same principle.

HIGH-PERFORMANCE BATTERY

Gerda engineers, in collaboration with the South Korean Research Institute, have developed a small dedicated high-performance battery. It powers the mechanism for six months of operation. And when in need of recharging, the lock will let you know as you can charge the battery overnight.

SAFETY WARRANTY

The lock actuating mechanism is an innovative, patented design developed by Gerda engineers. The software was created by Tedee IoT experts. An intuitive app lets you keep track of who and when has locked or unlocked the door. It also offers a virtual key allocation feature.

SET

TEDEE LOCK + TEDEE BRIDGE + CLASS 6 INSERTS



CLASS 6 LOCK INSERT INCLUDED

- ✓ ANTI-BURGLARY TUMBLER LOCK INSERT. NEW LOCK INSERT DESIGN SECURED AGAINST 'LOCK BUMPING', WITH EFFECTIVE DRILL OPENING PROTECTION.



INSTALL A TEDEE LOCK

- ✓ SLIDE THE LOCK ONTO A GERDA INSERT, ADJUST THE LOCK POSITION AND SECURE IT WITH ONE BOLT. INSTALLATION TAKES NO MORE THAN TWO MINUTES. INSPECT TO SEE WHETHER THE BOLTS SLIDE UPON TURNING THE KNOB.



INSTALL THE SMARTPHONE APP

- ✓ DOWNLOAD THE TEDEE APP FROM APPLE STORE OR GOOGLE PLAY. SIGN UP AND ACTIVATE YOUR BLUE-TOOTH, LOCATION SERVICE AND INTERNET ACCESS. ADD YOUR LOCK AND ENTER THE ACTIVATION CODE.



CONNECT THE BRIDGE

- ✓ FIND A FREE POWER SOCKET NEXT TO THE TEDEE LOCK AND PLUG THE BRIDGE IN. THIS WILL ENABLE YOU TO CONTROL THE LOCK OVER THE INTERNET FROM WHEREVER YOU ARE.

READILY AVAILABLE DOORS

GERDA®

OPTIMA 60



MILANO 8 NS1

DOOR MODEL	OPTIMA 60
SIZE	90E
COLOUR	ANTHRACITE (FKG), GOLD OAK (FDE)
DOOR FRAME	PERFOTHERM
GLASS	MATTE
SILL	ALUMINUM
EQUIPMENT	ESCUTCHEONS, LOCK BODY – DOOR HANDLE WITH INSERTS



HANOVER NS6

DOOR MODEL	OPTIMA 60
SIZE	90E
COLOUR	ANTHRACITE (FKG), GOLD OAK (FDE)
DOOR FRAME	PERFOTHERM
GLASS	MATTE
SILL	ALUMINUM
EQUIPMENT	ESCUTCHEONS, LOCK BODY – DOOR HANDLE WITH INSERTS

ASSEMBLED DOOR (DOOR LEAF + DOOR FRAME + SILL)



TOKIO 2A TMM

DOOR MODEL	OPTIMA 60
SIZE	80 90E
COLOUR	ANTHRACITE (FKG), GOLD OAK (FDE)
DOOR FRAME	PERFOTHERM
SILL	ALUMINUM
EQUIPMENT	ESCUTCHEONS, LOCK BODY – DOOR HANDLE WITH INSERTS



WOO FLAT

DOOR MODEL	OPTIMA 60
SIZE	80 90E
COLOUR	ANTHRACITE (FKG), GOLD OAK (FDE)
DOOR FRAME	PERFOTHERM
SILL	ALUMINUM
EQUIPMENT	ESCUTCHEONS, LOCK BODY – DOOR HANDLE WITH INSERTS

*DOOR READILY AVAILABLE ONLY IN THE ABOVE CONFIGURATION. DOOR SHIPPED FROM THE WAREHOUSE AT THE NEAREST POSSIBLE TIME.



DOORS

Our door frame and leaf solutions are perfect even for the most demanding facilities. Panel and metal doors in our offer feature superior durability, functionality (e.g. easy removal and replacement of a door panel) and the freedom of arrangement.



LOCKS AND FITTINGS

Security first. Heat-treated inner die casts or steel plates ensure high resistance to burglary. Hardened tumbler insert cover protects against wrenching off and prevents drilling.

The MASTER KEY system is a solution dedicated for commercial facilities. A single key may be used to open a pre-determined number of locks. This way, moving around the facility is quick and easy, while zone and room access management is very comfortable.



GATES

All garage gates in our offer comply with European standards. GERDA gates are fitted with comprehensive protection systems with no surcharge.

The "Trend" gate range is an economic but durable and functional solution, perfect for developer facilities.

The "Classic" gate range ensure very good thermal insulation, among others by means of 45-mm thick warm panels. Perfect for buildings with high energy efficiency requirements.



ALUMINUM JOINERY

GERDA also offers aluminum joinery. We build partition walls, doors, windows, shop windows and both indoor and outdoor spatial installations, also in fire-resistant and smoke-tight or high burglary-resistant versions.

WHAT SHOULD YOU KNOW ABOUT GERDA DOORS

THERMAL INSULATION

Heat transfer coefficient (U_d) indicates the amount of thermal energy passing through the door (including the door frame). Based on this coefficient, we are able to determine the heat loss for a given division. Even a slight loss translates to higher heating costs. The coefficient value depends on the type and thickness of the door's material. Gerda exterior doors comply with the current standards by using modern technologies and steel-wooden or aluminum door frames.

Gerda doors, depending on the components used, may have different insulation coefficient levels:

- insulation doors
- energy-saving doors
- passive doors

The basic doors in our offer, so-called insulation doors, have a coefficient below $1.3 \text{ W/m}^2\text{K}$. The door frame used is a steel PERFOTHERM® frame with thermal perforation, a seal and sill.

Energy-saving Optima 60 and Thermo Premium 60 doors have a coefficient starting from $0.9 \text{ W/m}^2\text{K}$ with a warm aluminum ALUTHERM door frame (with thermal chamber filling and a seal) and $1.0 \text{ W/m}^2\text{K}$ with DUOTHERM (warm steel-wooden door frame with thermal perforation and seal).

Passive doors are primarily meant to ensure maximum conservation of energy, while increasing the comfort of living. They allow for energy accumulation in the room, which leads to direct savings. Thermo Premium 75 doors feature a heat transfer coefficient from $0.79 \text{ W/m}^2\text{K}$. The heat transfer coefficient applies to solid doors with a warm aluminum ALUTHERM door frame.



RESISTANCE TO BURGLARY

This parameter is decisive for the so-called anti-burglary doors. Such doors have a solid structure that significantly impedes the possibility to cut out an opening through the door, preventing unauthorized entrance. As a standard, GERDA doors are fitted with two robust locks with a multi-point bolting system. Their key element are anti-prizing bolts that prevent forcing the door leaf or lifting it off the hinges. GERDA doors are tested for resistance to burglary and hold an anti-burglary protection class from RC2/RC3 to RC3. The higher the class of doors installed, the greater the safety of people and property in the house.



ANTI-BURGLARY PROTECTION CLASSES

RC2 CLASS

- PLIERS
- WEDGE
- HAMMER

RC3 CLASS

- STEEL PRY BAR
- WEDGE
- HAMMER
- MECHANICAL DRILL

RC4 CLASS

- HEAVY HAMMER
- AXE
- CHISEL
- BIT
- HAMMER DRILL

WHAT SHOULD YOU REMEMBER WHEN SELECTING GERDA DOORS

1

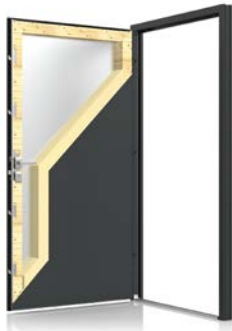

WHAT SHOULD YOU REMEMBER WHEN SELECTING GERDA DOORS

2



CHOOSE THE STRUCTURE THAT BEST FITS YOUR NEEDS

3

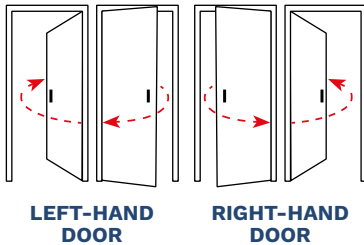

CHECK THE AVAILABLE WIDTHS AND DECIDE

4



ENJOY THE CUSTOM DESIGN OPTION

5



CHOOSE OPTIONAL ADDITIONAL ACCESSORIES: FANLIGHTS, HANDLES, PULLS, FRAMES

GERDA DOORS RANGE

GERDA®

PREMIUM PRODUCT



**MILANO 8
WINCHESTER**

**VILLACH
STEEL GRAY**

**INNSBRUCK
LIGHT WALNUT**



REGEN 5
DARK ANTHRACITE







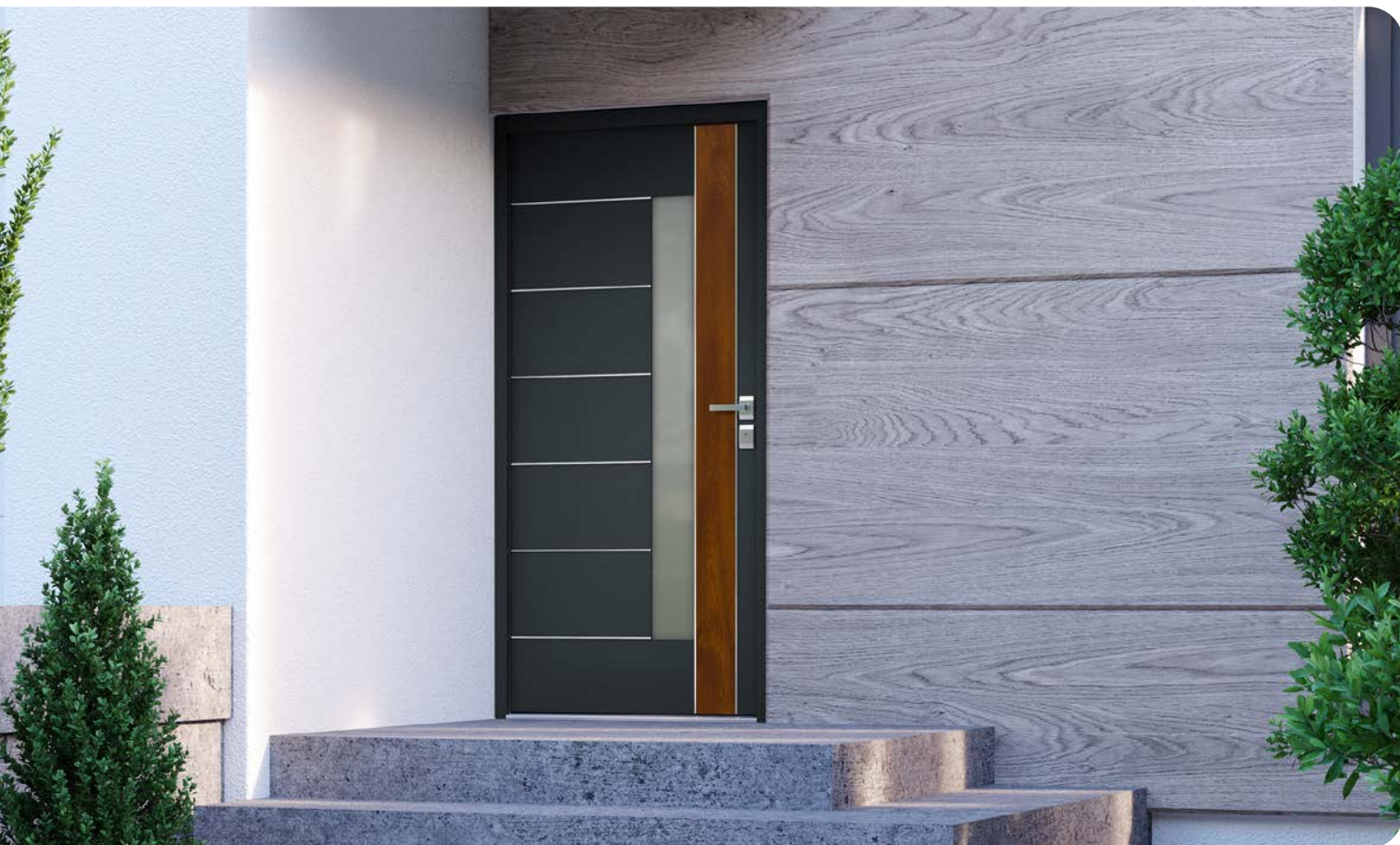

BAMBERG 3
LIGHT WENGE

GERDA **ERDA**[®]

THERMO PRIME 75



PARAMETERS

	THERMAL INSULATION	SOLID / GLAZED, ALUTHERM PRIME DOOR FRAME 0.79 W/m²K / 0.9 W/m²K
	ANTI-BURGLARY PROTECTION CLASS	RC2
	LEAF THICKNESS	75 mm
	DOOR SIZES	80, 90N, 90E, 100E*
	DESIGN LINES	4
	LEAF STRUCTURE	WOODEN FRAME + PUR FOAM
	CUSTOM-SIZE DOOR	DOOR HEIGHT UP TO 2400 mm

* SURCHARGE

SOLID / GLAZED DOOR,
ALUTHERM PRIME DOOR FRAME

UD = 0.79 / 0.9 W/m²K

SOLID / GLAZED DOOR,
STEEL DOOR FRAME

-

RC2

ALUTHERM PRIME DOOR FRAME



ADJUSTABLE HOOK HITCHES

Adjustable hook hitches with flexible teflon insert.



THERMAL DIVISION



3D HINGE WITH CAPS

Adjustable in three planes, caps in fitting colors



DOOR THICKNESS



5-POINT MORTISE LOCK

Lock installed along the entire height of the door leaf.

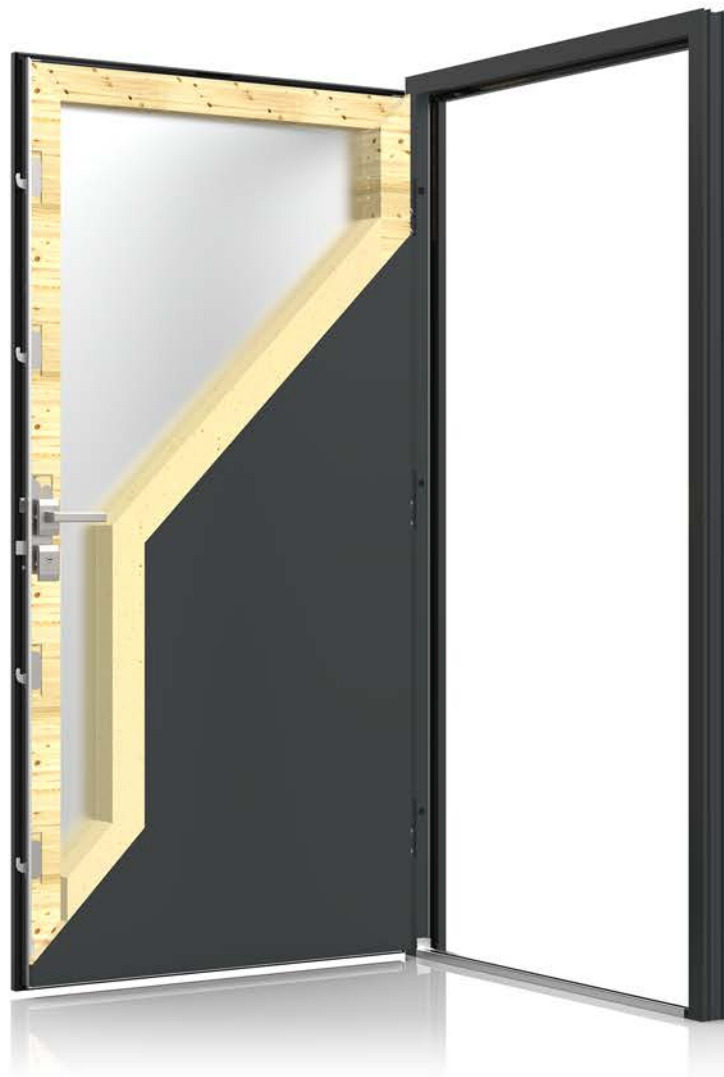

ADJUSTABLE PAWL HITCH

Enables smooth adjustment of the contact force of door and seals.



RING ESCUTCHEON

Available with a handhold



ANTI-PRIZING BOLTS

Fixed anti-prizing bolts in metal supports.



WARM ALUMINUM SILL WITH CONNECTOR



LOWER UPSTAND, PRIME BRUSH SEAL

ALUTHERM PRIME DOOR FRAME

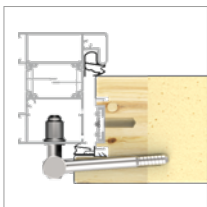

SILL

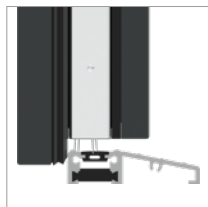

EXPLANATORY NOTES







* NET PRICE INCLUDES DOOR LEAF, SILL, DOOR FRAMES AND DOOR HANDLES WITH CLASS 5 INSERTS AND INSTALLATION SET.

■ Surcharge

GERDA THERMO PREMIUM 75



PARAMETERS

	THERMAL INSULATION	SOLID / GLAZED, DUOTHERM DOOR FRAME 0.9 W/m²K / 1.3 W/m²K	SOLID / GLAZED, ALUTHERM PREMIUM DOOR FRAME 0.8 W/m²K / 1.1 W/m²K
	ANTI-BURGLARY PROTECTION CLASS		RC2 / RC3*
	LEAF THICKNESS		75 mm
	DOOR SIZES		80, 90N, 90E, 100E**
	DESIGN LINES		4
	LEAF STRUCTURE	WOODEN FRAME + EXPANDED GRAPHITE POLYSTYRENE	

* ONLY SOLID DOOR, SURCHARGE
** SURCHARGE

**SOLID / GLAZED DOOR,
ALUTHERM PREMIUM DOOR FRAME**

UD = 0.8 / 1.1 W/m²K

**SOLID / GLAZED DOOR,
DUOTHERM DOOR FRAME**

UD = 0.9 / 1.3 W/m²K

RC2/RC3



VERTICAL BOLT

Anti-burglary vertical bolt controlled with the main lock for RC3



THERMAL DIVISION

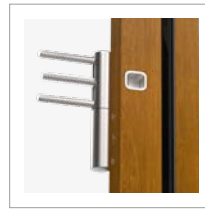

3D HINGE WITH CAPS

Adjustable in three planes, caps in fitting colors



DOOR THICKNESS



ADDITIONAL LOCK

3-bolt class 6
GERDA ZW 500



MAIN LOCK

Central lock
3-bolt class 7 GERDA ZW 2000



AUXILIARY LOCK

2-bolt



**ADJUSTABLE
PAWL HITCH**

Enables smooth adjustment of the contact force of door and seals.

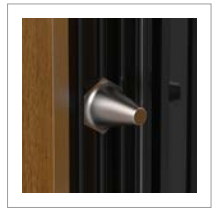

ANTI-PRIZING BOLTS

Fixed anti-prizing bolts in metal supports.



**LOWER UPSTAND,
BRUSH SEAL**

**ALUTHERM PREMIUM
DOOR FRAME**

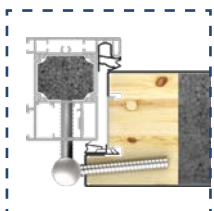

**DUOTHERM
DOOR FRAME**



SILL

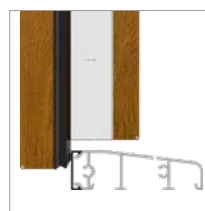

**EXPLANATORY
NOTES**

* NET PRICE INCLUDES DOOR LEAF, SILL, DOOR FRAMES AND DOOR HANDLES WITH CLASS 5 INSERTS AND INSTALLATION SET.

■ Surcharge

GERDA THERMO PREMIUM 60



PARAMETERS

UD	THERMAL INSULATION	SOLID / GLAZED, DUOTHERM DOOR FRAME 1.0 W/m²K / 1.3 W/m²K	SOLID / GLAZED, ALUTHERM PREMIUM DOOR FRAME 0.9 W/m²K / 1.2 W/m²K
RC	ANTI-BURGLARY PROTECTION CLASS		RC2 / RC3*
K mm	LEAF THICKNESS		60 mm
D	DOOR SIZES		80, 90N, 90E, 100E*
G	DESIGN LINES		4
W	LEAF STRUCTURE	WOODEN FRAME + EXPANDED GRAPHITE POLYSTYRENE	

* SURCHARGE

**SOLID / GLAZED DOOR,
ALUTHERM PREMIUM DOOR FRAME**

UD = 0.9 / 1.2 W/m²K

**SOLID / GLAZED DOOR,
DUOTHERM DOOR FRAME**

UD = 1.0 / 1.3 W/m²K

RC2/RC3



VERTICAL BOLT

Anti-burglary vertical bolt controlled with the main lock for RC3

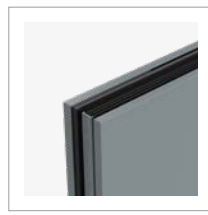

THERMAL DIVISION



3D HINGE WITH CAPS

Adjustable in three planes, caps in fitting colors



DOOR THICKNESS



ADDITIONAL LOCK

3-bolt class 6
GERDA ZW 500



MAIN LOCK

3-ryglowy klasy 7 GERDA ZW1000,
dla RC3 zamek centralny ZW2000



AUXILIARY LOCK

2-bolt for RC3

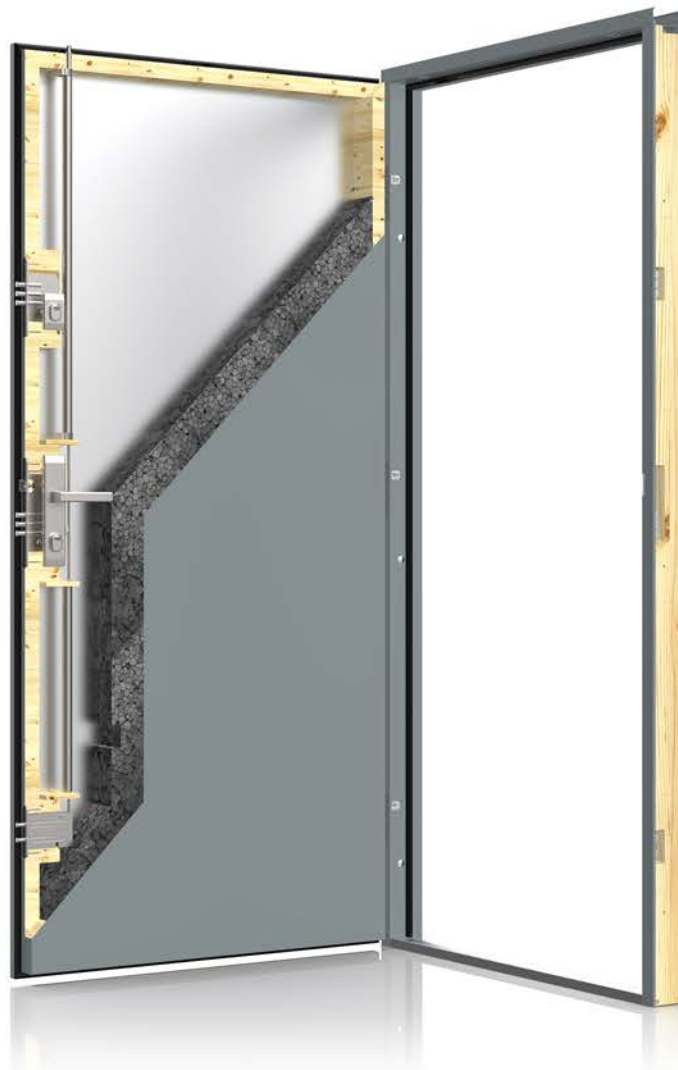

ADJUSTABLE PAWL HITCH

Enables smooth adjustment of the contact force of door and seals.



ANTI-PRIZING BOLTS

Fixed anti-prizing bolts in metal supports.



**LOWER UPSTAND,
BRUSH SEAL**

**ALUTHERM PREMIUM
DOOR FRAME**



**DUOTHERM
DOOR FRAME**



SILL

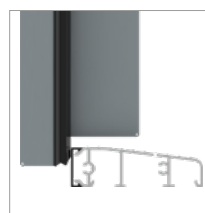

**EXPLANATORY
NOTES**

* NET PRICE INCLUDES DOOR LEAF, SILL, DOOR FRAMES AND DOOR HANDLES WITH CLASS 5 INSERTS AND INSTALLATION SET.

— Surcharge

AIR GLASS



AGB LINZ 1 p. 26



AGC LINZ 2 p. 26



AGD LINZ 3 p. 27



AGDB LINZ 3 B p. 27



AGE GRAZ 1 p. 28



AGF GRAZ 2 p. 28



AGG GRAZ 3 p. 29

QUADRO



KWA PASAWA 1 p. 32



KWB PASAWA 2 p. 32



KWC PASAWA 3 p. 33



KWD PASAWA 4 p. 33



KWE JENA 3 p. 34



KW4 JENA 4 p. 34



KWF BAMBERG 1 p. 36



KWN TREWIR 3 p. 41



KWP TREWIR 4 p. 41



KW7 TREWIR 7 p. 41



KWS DORFEN p. 42



KWT KASSEL 1 p. 44



KWX KASSEL 2 p. 44



KPN KRONACH 1 p. 46



KPM REGEN 5 p. 49



KPR REGEN 6 p. 49



KPRB REGEN 6 B p. 49



KPE DREZNO 1 p. 50



KPF DREZNO 2 p. 50



KPH DREZNO 4 p. 51



KPA ERFURT 1 p. 52

ELITE 3D



ELA BRIG p. 54



ELB OLTEN p. 54



ELC VISP p. 55



ELD TRIN p. 55



ELE BERNO p. 55

TEMPO



NS1 MILANO 8 p. 56



NS2 MILANO 9 p. 56



AGGB GRAZ 3 B p. 29



AGA SALZBURG p. 30



AGH VILLACH p. 30



AGHB VILLACH B p. 30



KWG BAMBERG 2 p. 36



KWH BAMBERG 3 p. 37



KWI BAMBERG 4 p. 37



KWJ ULM 1 p. 38

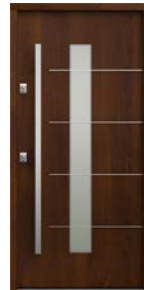

KWK ULM 2 p. 38



KWL TREWIR 1 p. 40



KWM TREWIR 2 p. 40



KPP KRONACH 2 p. 46



KPT KRONACH 3 p. 47



KPZ KRONACH 4 p. 47



KPJ REGEN 1 p. 48



KPK REGEN 2 p. 48



KPL REGEN 3 p. 49



KPS REGEN 4 p. 49



KPB ERFURT 2 p. 52



KPC ERFURT 3 p. 53



NS3 MILANO 10 p. 57



NS4 MILANO 11 p. 57



NS9B MILANO 12 B p. 57



NSSB HANOVER 5 B p. 58



NS6 HANOVER 6 p. 58



NS7 INNSBRUCK p. 59



W00 FLAT p. 60

GERDA OPTIMA 60



PARAMETERS

UD	THERMAL INSULATION	SOLID / GLAZED, PERFOTHERM DOOR FRAME 1.1 W/m²K / 1.3 W/m²K	SOLID / GLAZED, ALUTHERM PREMIUM DOOR FRAME 1.0 W/ 1.3 W/m²K
RC	ANTI-BURGLARY PROTECTION CLASS		RC2 / RC3*
K mm	LEAF THICKNESS		60 mm
D	DOOR SIZES		80N, 80, 90N, 90E, 100E**
G	DESIGN LINES		2
W	LEAF STRUCTURE	WOODEN BLOCKS + WOODEN FRAME + EXPANDED GRAPHITE POLYSTYRENE	

* ONLY SOLID DOOR, SURCHARGE
** SURCHARGE

**SOLID / GLAZED DOOR,
ALUTHERM PREMIUM DOOR FRAME**

UD = 1.0 / 1.3 W/m²K

**SOLID / GLAZED DOOR,
DUOTHERM DOOR FRAME**

UD = 1.1 / 1.3 W/m²K

RC2/RC3



VERTICAL BOLT

Anti-burglary vertical bolt controlled with the main lock for RC3

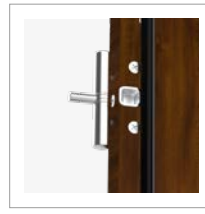

2D HINGE WITH CAPS

Caps in fitting colors



DOOR THICKNESS



ADDITIONAL LOCK

3-bolt class 6
GERDA ZW 500



MAIN LOCK

3-bolt class 7 GERDA ZW 1000,
ZW 2000 central lock for RC3



AUXILIARY LOCK

2-bolt for RC3



**ADJUSTABLE
PAWL HITCH**

Enables smooth adjustment of the contact force of door and seals.



ANTI-PRIZING BOLTS

Fixed anti-prizing bolts in metal supports.

**ALUTHERM OPTIMA
DOOR FRAME**

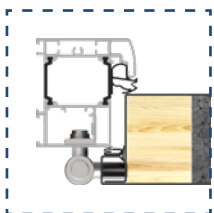

**PERFOTHERM
DOOR FRAME**

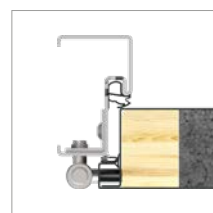

SILL







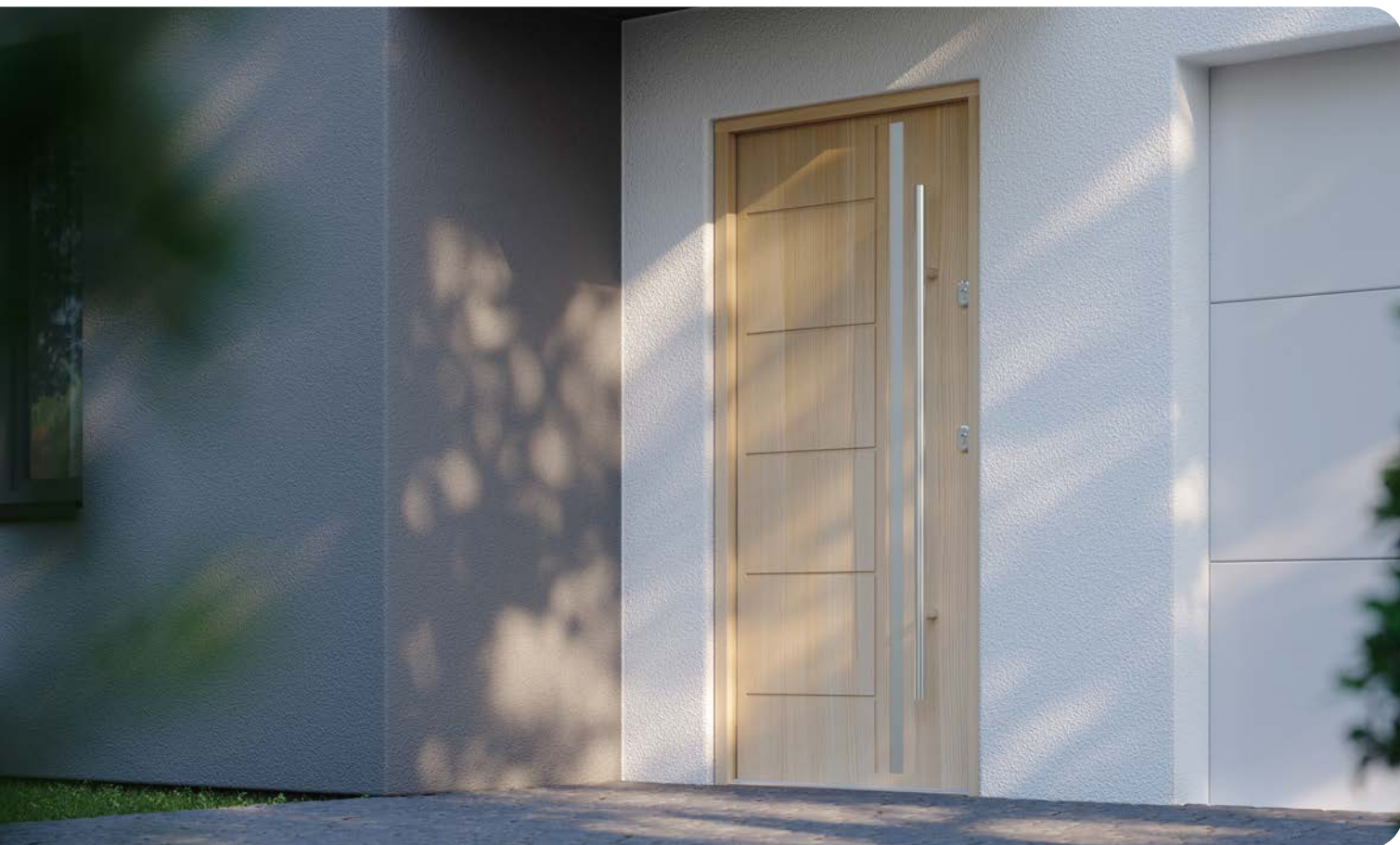

**EXPLANATORY
NOTES**

* NET PRICE INCLUDES DOOR LEAF, SILL, DOOR FRAMES AND DOOR HANDLES WITH CLASS 5 INSERTS AND INSTALLATION SET.

■ Surcharge



PARAMETERS

	THERMAL INSULATION	SOLID PERFOTHERM DOOR FRAME 1.2 W/m²K
	ANTI-BURGLARY PROTECTION CLASS	RC2
	LEAF THICKNESS	50 mm
	DOOR SIZES	80N, 80, 90N, 90E, 100E*
	DESIGN LINES	2
	LEAF STRUCTURE	WOODEN BLOCKS + WOODEN FRAME + EXPANDED GRAPHITE POLYSTYRENE

* SURCHARGE

SOLID / GLAZED DOOR,
ALUMINUM DOOR FRAME



SOLID / GLAZED DOOR,
PERFOTHERM DOOR FRAME



2D HINGE WITH CAPS
Caps in fitting colors



DOOR THICKNESS

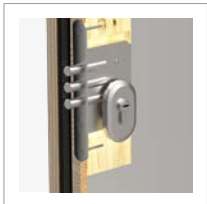

ADDITIONAL LOCK
3-bolt class 6
GERDA ZW 500

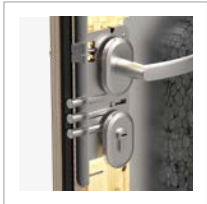

MAIN LOCK
3-bolt class 7
GERDA ZW 1000



ADJUSTABLE PAWL HITCH
Enables smooth adjustment of the contact force of door and seals.



ANTI-PRIZING BOLTS
Fixed anti-prizing bolts in metal supports.

PERFOTHERM
DOOR FRAME

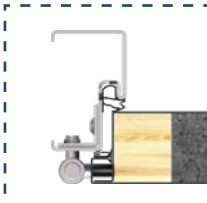

* COMPATIBLE WITH WOODEN SILLS

FB
DOOR FRAME

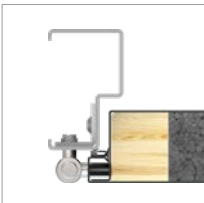

FN
DOOR FRAME



SILL



EXPLANATORY
NOTES

* NET PRICE INCLUDES DOOR LEAF, SILL, DOOR FRAMES AND DOOR HANDLES WITH CLASS 5 INSERTS AND INSTALLATION SET.
— Surcharge

GERDA EXTERIOR DOORS

GERDA®

TEMPO



NS1 MILANO 8 p. 56



NS2 MILANO 9 p. 56



NS3 MILANO 10 p. 57



NS4 MILANO 11 p. 57



NS9 MILANO 12 p. 57



NS9B MILANO 12 B p. 57



NS5 HANOVER 5 p. 58



NT1 TURYN 1 p. 64



NT2 TURYN 2 p. 65



SOJ BERGAMO 2 p. 66



SJ9 NICEA 9 p. 66



SBE BERLIN 4 p. 67



ST4 UPPSALA 1 p. 68



ST4A UPPSALA 1A p. 68



ST9 LUND 1 p. 72



WBA ASPEN 1 p. 73



TN7 ASPEN 2 p. 73



TN7B ASPEN 2B p. 73



SR3 TROMSO 1 p. 74



SR4 TROMSO 1 p. 74



SR5 TROMSO 2 p. 75

CLASSIC



W76 MODENA p. 76



W77 MODENA 2 p. 76



W78 MODENA 3 p. 77



WDR RAVENA p. 77



WJ1 NICEA 5 p. 78



W23 OLYMPIA p. 79



W91 WERONA p. 80



W24 LIZBONA p. 82



W9N WENECJA p. 82



W13 LONDYN p. 83



W5L LONDYN 1 p. 83



W54 BARCELONA p. 84



W53 BARCELONA 1 p. 84



G76 GENEWA 1 p. 85



NS5B HANOVER 5 B p. 58



NS6 HANOVER 6 p. 58



NS7 INNSBRUCK p. 59



W00 FLAT p. 60



W00 FLAT p. 60



SNU MILANO 4 p. 62



SNUA MILANO 4A p. 62



ST5 UPPSALA 2 p. 69



ST5A UPPSALA 2A p. 69



TML TOKIO 1 p. 70



TMLA TOKIO 1A p. 70



TMM TOKIO 2 p. 71



TMMa TOKIO 2A p. 71



ST8 RYGA p. 72



SR5 TROMSO 2 p. 75



W94 WERONA 1 p. 80



W93 WERONA 3 p. 81



W6A WERONA 4 p. 81



WQA WERONA 5 p. 81



G75 GENEWA 2 p. 85



D75 GENEWA 3 p. 85

AIR GLASS LINZ

GERDA®



AGB LINZ 1



AGC LINZ 2

SIZE	80	90N	90E	100E
------	----	-----	-----	------

MODEL	THERMO PREMIUM 60	THERMO PREMIUM 75	THERMO PRIME 75
AGB / AGBB LINZ 1	✓	✓	✓
AGC / AGCB LINZ 2	✓	✓	✓
AGD / AGDB LINZ 3	✓	✓	✓

RC2 STANDARD EQUIPMENT

- GLAZED DOOR LEAF, COMPLIANT WITH THE "CLEAN AIR" PROGRAM TERMS
- 4 DOOR LEAF UPSTANDS
- THERMO PREMIUM DUOTHERM / THERMO PRIME DOOR FRAME ALUTHERM PRIME DOOR FRAME
- 3D-ADJUSTABLE HINGES WITH CAPS IN FITTING COLORS
- INSERTS **INOX** **BLACK**
- WARM SILL
- FITTINGS SET WITH INSERT PROTECTION
- BERGEN ESCUTCHEONS WITH ALEX HANDLES
- CLASS 5 LOCK INSERTS, ONE KEY SYSTEM FOR THERMO PREMIUM DOORS

SURCHARGES

ALUTHERM PREMIUM DOOR FRAME (THERMO PREMIUM DOOR)	✓	AMSTERDAM / MONTREAL HANDHOLD 1500 mm, RECOMMENDED ELECTRIC STRIKE	✓
TWO-COLOR DOOR	✓	AMSTERDAM / MONTREAL HANDHOLD 1000 mm, RECOMMENDED ELECTRIC STRIKE	✓
CLASS 6 LOCK INSERTS, ONE KEY SYSTEM	✓	AMSTERDAM / MONTREAL HANDHOLD 1500 mm WITH PUSHBUTTON, WITH DOOR LEAF ADJUSTMENT, ELECTRIC STRIKE REQUIRED	✓
UPPER ESCUTCHEON PROTECTION (THERMO PREMIUM)	✓	AMSTERDAM / MONTREAL HANDHOLD 1000 mm WITH PUSHBUTTON, WITH DOOR LEAF ADJUSTMENT, ELECTRIC STRIKE REQUIRED	✓
KNOB-HANDLE	✓	ELECTRIC STRIKE WITH DAY / NIGHT FEATURE	✓
SIZE 100E	✓	REED SWITCH	✓
		TEDEE SET	✓

* FIXED ALUMINUM ILLUMINATORS – PAGES 88–89, FULL EQUIPMENT LIST – PAGES 94–99

GLASS



GRAPHITE

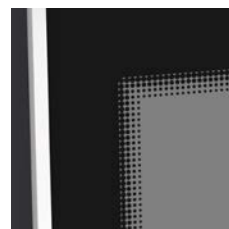

INOX



BLACK

DOOR COLORS

ALPINE WALNUT



FRR

MAHOGANY



FMA

BRAZILIAN WALNUT



FRB

LIGHT WALNUT



FRP

GOLD OAK



FDE

WINCHESTER



FDW

LIGHT WENGE



FEJ

WHITE



FSB

STEEL GRAY



FKZ

ANTHRACITE



FKG

DARK ANTHRACITE



FKF

BLACK



FKC



AGD LINZ 3



INTERNAL SIDE

THERMO PRIME 75 DOOR CONFIGURATION



AGDB LINZ 3 B



INTERNAL SIDE

FITTINGS

HANDLE-HANDLE



THERMO PRIME



THERMO PREMIUM

HANDLE-KNOB



THERMO PRIME



THERMO PREMIUM

HANDHOLD



□ AMSTERDAM
○ MONTREAL

FITTING COLORS

ANODED PLATINUM



ANODED SILVER



ANODED BLACK



DOOR COLORS

ALPINE WALNUT



FRR

MAHOGANY



FMA

BRAZILIAN WALNUT



FRB

LIGHT WALNUT



FRP

GOLD OAK



FDE

WINCHESTER



FDW

LIGHT WENGE



FEJ

WHITE



FSB

STEEL GRAY



FKZ

ANTHRACITE



FKG

DARK ANTHRACITE



FKF

BLACK



FKC

AIR GLASS GRAZ

GERDA®



AGE GRAZ 1



AGF GRAZ 2

SIZE	80	90N	90E	100E
------	----	-----	-----	------

MODEL	THERMO PREMIUM 60	THERMO PREMIUM 75	THERMO PRIME 75
AGE / AGEB GRAZ 1	✓	✓	✓
AGF / AGFB GRAZ 2	✓	✓	✓
AGG / AGGB GRAZ 3	✓	✓	✓

RC2 STANDARD EQUIPMENT

- GLAZED DOOR LEAF, COMPLIANT WITH THE "CLEAN AIR" PROGRAM TERMS
- 4 DOOR LEAF UPSTANDS
- THERMO PREMIUM DUOTHERM / THERMO PRIME DOOR FRAME ALUTHERM PRIME DOOR FRAME
- 3D-ADJUSTABLE HINGES WITH CAPS IN FITTING COLORS
- INSERTS **INOX** **BLACK**
- WARM SILL
- FITTINGS SET WITH INSERT PROTECTION
- BERGEN ESCUTCHEONS WITH ALEX HANDLES
- CLASS 5 LOCK INSERTS, ONE KEY SYSTEM FOR THERMO PREMIUM DOORS

SURCHARGES

ALUTHERM PREMIUM DOOR FRAME (THERMO PREMIUM DOOR)	✓	AMSTERDAM / MONTREAL HANDHOLD 1500 mm, RECOMMENDED ELECTRIC STRIKE	✓
TWO-COLOR DOOR	✓	AMSTERDAM / MONTREAL HANDHOLD 1000 mm, RECOMMENDED ELECTRIC STRIKE	✓
CLASS 6 LOCK INSERTS, ONE KEY SYSTEM	✓	AMSTERDAM / MONTREAL HANDHOLD 1500 mm WITH PUSHBUTTON, WITH DOOR LEAF ADJUSTMENT, ELECTRIC STRIKE REQUIRED	✓
UPPER ESCUTCHEON PROTECTION (THERMO PREMIUM)	✓	AMSTERDAM / MONTREAL HANDHOLD 1000 mm WITH PUSHBUTTON, WITH DOOR LEAF ADJUSTMENT, ELECTRIC STRIKE REQUIRED	✓
KNOB-HANDLE	✓	ELECTRIC STRIKE WITH DAY / NIGHT FEATURE	✓
SIZE 100E	✓	REED SWITCH	✓
		TEDEE SET	✓

* FIXED ALUMINUM ILLUMINATORS – PAGES 88–89, FULL EQUIPMENT LIST – PAGES 94–99

GLASS



GRAPHITE

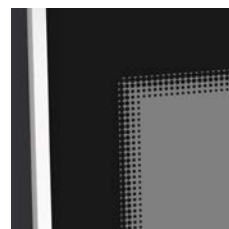

INOX

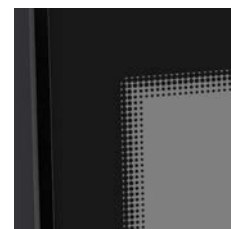

BLACK

DOOR COLORS

ALPINE WALNUT



FRR

MAHOGANY



FMA

BRAZILIAN WALNUT



FRB

LIGHT WALNUT



FRP

GOLD OAK



FDE

WINCHESTER



FDW

LIGHT WENGE



FEJ

WHITE



FSB

STEEL GRAY



FKZ

ANTHRACITE



FKG

DARK ANTHRACITE



FKF

BLACK



FKC



AGGB GRAZ 3 B



INTERNAL SIDE

THERMO PRIME 75 DOOR CONFIGURATION



AGF GRAZ 2



INTERNAL SIDE

FITTINGS

HANDLE-HANDLE



THERMO PRIME



THERMO PREMIUM

HANDLE-KNOB



THERMO PRIME



THERMO PREMIUM

HANDHOLD



□ AMSTERDAM
○ MONTREAL

FITTING COLORS

ANODED PLATINUM



ANODED SILVER



ANODED BLACK



DOOR COLORS

ALPINE WALNUT



FRR

MAHOGANY



FMA

BRAZILIAN WALNUT



FRB

LIGHT WALNUT



FRP

GOLD OAK



FDE

WINCHESTER



FDW

LIGHT WENGE



FEJ

WHITE



FSB

STEEL GRAY



FKZ

ANTHRACITE



FKG

DARK ANTHRACITE



FKF

BLACK



FKC

AIR GLASS SALZBURG / VILLACH



AGA SALZBURG



AGHB VILLACH B

SIZE (AGA SALZBURG)	80	90N	90E	100E
SIZE (AGH VILLACH)	-	-	90E	100E

MODEL	THERMO PREMIUM 60	THERMO PREMIUM 75	THERMO PRIME 75
AGA / AGAB SALZBURG	✓	✓	✓
AGH / AGHB VILLACH	✓	✓	✓

RC2 STANDARD EQUIPMENT

- GLAZED DOOR LEAF, COMPLIANT WITH THE "CLEAN AIR" PROGRAM TERMS
- 4 DOOR LEAF UPSTANDS
- THERMO PREMIUM DUOTHERM / THERMO PRIME DOOR FRAME ALUTHERM PRIME DOOR FRAME
- 3D-ADJUSTABLE HINGES WITH CAPS IN FITTING COLORS
- WARM SILL
- FITTINGS SET WITH INSERT PROTECTION
- BERGEN ESCUTCHEONS WITH ALEX HANDLES
- CLASS 5 LOCK INSERTS, ONE KEY SYSTEM FOR THERMO PREMIUM DOORS

• INSERTS **INOX** **BLACK**

SURCHARGES

CUSTOM HEIGHT (THERMO PRIME)	2150 - 2200 mm	✓
AGH / AGHB DESIGN ONLY	2250 - 2300 mm	✓
AVAILABLE COLORS: FRP, FDE, FDW, FKG, FKF	2350 - 2400 mm	✓
ALUTHERM PREMIUM DOOR FRAME (THERMO PREMIUM DOOR)	✓ AMSTERDAM / MONTREAL HANDHOLD 1500 mm, RECOMMENDED ELECTRIC STRIKE	✓
TWO-COLOR DOOR	✓ AMSTERDAM / MONTREAL HANDHOLD 1000 mm, RECOMMENDED ELECTRIC STRIKE	✓
CLASS 6 LOCK INSERTS, ONE KEY SYSTEM	✓ AMSTERDAM / MONTREAL HANDHOLD 1500 mm WITH PUSHBUTTON, WITH DOOR LEAF ADJUSTMENT, ELECTRIC STRIKE REQUIRED	✓
UPPER ESCUTCHEON PROTECTION (THERMO PREMIUM)	✓ AMSTERDAM / MONTREAL HANDHOLD 1000 mm WITH PUSHBUTTON, WITH DOOR LEAF ADJUSTMENT, ELECTRIC STRIKE REQUIRED	✓
KNOB-HANDLE	✓ ELECTRIC STRIKE WITH DAY / NIGHT FEATURE	✓
SIZE 100E	✓ REED SWITCH	✓
	TEDEE SET	✓

* FIXED ALUMINUM ILLUMINATORS - PAGES 88-89, FULL EQUIPMENT LIST - PAGES 94-99

GLASS



GRAPHITE

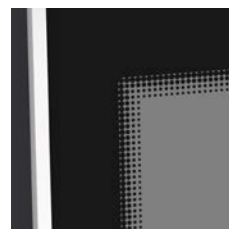

INOX



BLACK

DOOR COLORS

ALPINE WALNUT



FRR

MAHOGANY



FMA

BRAZILIAN WALNUT



FRB

LIGHT WALNUT



FRP

GOLD OAK



FDE

WINCHESTER



FDW

LIGHT WENGE



FEJ

WHITE



FSB

STEEL GRAY



FKZ

ANTHRACITE



FKG

DARK ANTHRACITE



FKF

BLACK



FKC



AGA SALZBURG

THERMO PRIME 75 DOOR CONFIGURATION



INTERNAL SIDE

INTERNAL SIDE

FITTINGS

HANDLE-HANDLE



THERMO PRIME



THERMO PREMIUM

HANDLE-KNOB



THERMO PRIME



THERMO PREMIUM

HANDHOLD



- AMSTERDAM
- MONTREAL

FITTING COLORS

ANODED PLATINUM



ANODED SILVER



ANODED BLACK



DOOR COLORS

ALPINE WALNUT



FRR

MAHOGANY



FMA

BRAZILIAN WALNUT



FRB

LIGHT WALNUT



FRP

GOLD OAK



FDE

WINCHESTER



FDW

LIGHT WENGE



FEJ

WHITE



FSB

STEEL GRAY



FKZ

ANTHRACITE



FKG

DARK ANTHRACITE



FKF

BLACK



FKC



KWA PASAWA 1



KWB PASAWA 2

SIZE	80	90N	90E	100E
-------------	----	-----	-----	------

MODEL	THERMO PREMIUM 60	THERMO PREMIUM 75	THERMO PRIME 75
KWA / KWAB PASAWA 1	✓	✓	✓
KWB / KWBB PASAWA 2	✓	✓	✓
KWC / KWCB PASAWA 3	✓	✓	✓
KWD / KWDB PASAWA 4	✓	✓	✓

RC2 STANDARD EQUIPMENT

- GLAZED DOOR LEAF, COMPLIANT WITH THE "CLEAN AIR" PROGRAM TERMS
- 4 DOOR LEAF UPSTANDS
- THERMO PREMIUM DUOTHERM / THERMO PRIME DOOR FRAME ALUTHERM PRIME DOOR FRAME
- 3D-ADJUSTABLE HINGES WITH CAPS IN FITTING COLORS
- WARM SILL
- FITTINGS SET WITH INSERT PROTECTION
- BERGEN ESCUTCHEONS WITH ALEX HANDLES
- CLASS 5 LOCK INSERTS, ONE KEY SYSTEM FOR THERMO PREMIUM DOORS

• INSERTS INOX BLACK

SURCHARGES

CUSTOM HEIGHT (THERMO PRIME)	2150 - 2200 mm	✓
AVAILABLE COLORS: FRP, FDE, FDW, FKG, FKF	2250 - 2300 mm	✓
	2350 - 2400 mm	✓
ALUTHERM PREMIUM DOOR FRAME (THERMO PREMIUM DOOR)	✓	AMSTERDAM / MONTREAL HANDHOLD 1500 mm, RECOMMENDED ELECTRIC STRIKE ✓
SIZE 100E	✓	AMSTERDAM / MONTREAL HANDHOLD 1000 mm, RECOMMENDED ELECTRIC STRIKE ✓
DOOR SHORTENING KWA, KWB, KWC (10, 20, 30, 40 mm), KWD (10, 20, 30, 40, 60, 80, 100 mm)	✓	AMSTERDAM / MONTREAL HANDHOLD 1500 mm WITH PUSHBUTTON, WITH DOOR LEAF ADJUSTMENT, ELECTRIC STRIKE REQUIRED ✓
TWO-COLOR DOOR	✓	AMSTERDAM / MONTREAL HANDHOLD 1000 mm WITH PUSHBUTTON, WITH DOOR LEAF ADJUSTMENT, ELECTRIC STRIKE REQUIRED ✓
CLASS 6 LOCK INSERTS, ONE KEY SYSTEM	✓	ELECTRIC STRIKE WITH DAY / NIGHT FEATURE ✓
UPPER ESCUTCHEON PROTECTION (THERMO PREMIUM)	✓	REED SWITCH ✓
KNOB-HANDLE	✓	TEDEE SET ✓

* FIXED ALUMINUM ILLUMINATORS – PAGES 88-89, FULL EQUIPMENT LIST – PAGES 94-99

GLASS



MATTE



MIRA STAR (MIRROR GLASS)

DOOR COLORS

ALPINE WALNUT



FRR

MAHOGANY



FMA

BRAZILIAN WALNUT



FRB

LIGHT WALNUT



FRP

GOLD OAK



FDE

WINCHESTER



FDW

LIGHT WENGE



FEJ

WHITE



FSB

STEEL GRAY



FKZ

ANTHRACITE



FKG

DARK ANTHRACITE



FKF

BLACK



FKC



KWCB PASAWA 3 B



KWD PASAWA 4



INTERNAL SIDE

THERMO PRIME 75 DOOR CONFIGURATION



KWA PASAWA 1



INTERNAL SIDE

FITTINGS

HANDLE-HANDLE



THERMO PRIME



THERMO PREMIUM

HANDLE-KNOB



THERMO PRIME



THERMO PREMIUM

HANDHOLD



□ AMSTERDAM
○ MONTREAL

FITTING COLORS

ANODED PLATINUM



ANODED SILVER



ANODED BLACK



DOOR COLORS

ALPINE WALNUT



FRR

MAHOGANY



FMA

BRAZILIAN WALNUT



FRB

LIGHT WALNUT



FRP

GOLD OAK



FDE

WINCHESTER



FDW

LIGHT WENGE



FEJ

WHITE



FSB

STEEL GRAY



FKZ

ANTHRACITE



FKG

DARK ANTHRACITE



FKF

BLACK



FKC



KW3 JENA 3



KW4 JENA 4

SIZE	80	90N	90E	100E
------	----	-----	-----	------

MODEL	THERMO PREMIUM 60	THERMO PREMIUM 75	THERMO PRIME 75
KW3 / KW3B JENA 3	✓	✓	✓
KW4 / KW4B JENA 4	✓	✓	✓

RC2 STANDARD EQUIPMENT

- GLAZED DOOR LEAF, COMPLIANT WITH THE "CLEAN AIR" PROGRAM TERMS
- 4 DOOR LEAF UPSTANDS
- THERMO PREMIUM DUOTHERM / THERMO PRIME DOOR FRAME ALUTHERM PRIME DOOR FRAME
- 3D-ADJUSTABLE HINGES WITH CAPS IN FITTING COLORS
- WARM SILL
- FITTINGS SET WITH INSERT PROTECTION
- BERGEN ESCUTCHEONS WITH ALEX HANDLES
- CLASS 5 LOCK INSERTS, ONE KEY SYSTEM FOR THERMO PREMIUM DOORS

SURCHARGES

CUSTOM HEIGHT (THERMO PRIME) AVAILABLE COLORS: FRP, FDE, FDW, FKG, FKF	2150 - 2200 mm	✓	
	2250 - 2300 mm	✓	
	2350 - 2400 mm	✓	
ALUTHERM PREMIUM DOOR FRAME (THERMO PREMIUM DOOR)	✓	AMSTERDAM / MONTREAL HANDHOLD 1500 mm, RECOMMENDED ELECTRIC STRIKE	✓
SIZE 100E	✓	AMSTERDAM / MONTREAL HANDHOLD 1000 mm, RECOMMENDED ELECTRIC STRIKE	✓
DOOR SHORTENING (10, 20, 30, 40, 60, 80, 100 mm)	✓	AMSTERDAM / MONTREAL HANDHOLD 1500 mm WITH PUSHBUTTON, WITH DOOR LEAF ADJUSTMENT, ELECTRIC STRIKE REQUIRED	✓
TWO-COLOR DOOR	✓	AMSTERDAM / MONTREAL HANDHOLD 1000 mm WITH PUSHBUTTON, WITH DOOR LEAF ADJUSTMENT, ELECTRIC STRIKE REQUIRED	✓
CLASS 6 LOCK INSERTS, ONE KEY SYSTEM	✓	ELECTRIC STRIKE WITH DAY / NIGHT FEATURE	✓
UPPER ESCUTCHEON PROTECTION (THERMO PREMIUM)	✓	REED SWITCH	✓
KNOB-HANDLE	✓	TEDEE SET	✓

* FIXED ALUMINUM ILLUMINATORS - PAGES 88-89, FULL EQUIPMENT LIST - PAGES 94-99

GLASS



MATTE



MIRA STAR (MIRROR GLASS)

DOOR COLORS

ALPINE WALNUT



FRR

MAHOGANY



FMA

BRAZILIAN WALNUT



FRB

LIGHT WALNUT



FRP

GOLD OAK



FDE

WINCHESTER



FDW

LIGHT WENGE



FEJ

WHITE

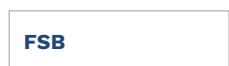

FSB

STEEL GRAY



FKZ

ANTHRACITE



FKG

DARK ANTHRACITE



FKF

BLACK



FKC



KW3B JENA 3 B

THERMO PRIME 75 DOOR CONFIGURATION



INTERNAL SIDE

INTERNAL SIDE

FITTINGS

HANDLE-HANDLE



THERMO PRIME



THERMO PREMIUM

HANDLE-KNOB



THERMO PRIME



THERMO PREMIUM

HANDHOLD

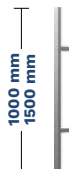

- AMSTERDAM
- MONTREAL

FITTING COLORS

ANODED PLATINUM



ANODED SILVER



ANODED BLACK



DOOR COLORS

ALPINE WALNUT



FRR

MAHOGANY



FMA

BRAZILIAN WALNUT



FRB

LIGHT WALNUT



FRP

GOLD OAK



FDE

WINCHESTER



FDW

LIGHT WENGE



FEJ

WHITE



FSB

STEEL GRAY



FKZ

ANTHRACITE



FKG

DARK ANTHRACITE



FKF

BLACK



FKC



KWF BAMBERG 1



KWG BAMBERG 2

SIZE	80	90N	90E	100E
------	----	-----	-----	------

MODEL	THERMO PREMIUM 60	THERMO PREMIUM 75	THERMO PRIME 75
KWF / KWFB BAMBERG 1	✓	✓	✓
KWG / KWGB BAMBERG 2	✓	✓	✓
KWH / KWHB BAMBERG 3	✓	✓	✓
KWI / KWIB BAMBERG 4	✓	✓	✓

RC2 STANDARD EQUIPMENT

- GLAZED DOOR LEAF, COMPLIANT WITH THE "CLEAN AIR" PROGRAM TERMS
- 4 DOOR LEAF UPSTANDS
- THERMO PREMIUM DUOTHERM / THERMO PRIME DOOR FRAME ALUTHERM PRIME DOOR FRAME
- 3D-ADJUSTABLE HINGES WITH CAPS IN FITTING COLORS
- WARM SILL
- FITTINGS SET WITH INSERT PROTECTION
- BERGEN ESCUTCHEONS WITH ALEX HANDLES
- CLASS 5 LOCK INSERTS, ONE KEY SYSTEM FOR THERMO PREMIUM DOORS

• INSERTS **INOX** **BLACK**

SURCHARGES

CUSTOM HEIGHT (THERMO PRIME)	2150 - 2200 mm	✓
AVAILABLE COLORS: FRP, FDE, FDW, FKG, FKF	2250 - 2300 mm	✓
	2350 - 2400 mm	✓
ALUTHERM PREMIUM DOOR FRAME (THERMO PREMIUM DOOR)	✓	AMSTERDAM / MONTREAL HANDHOLD 1500 mm, RECOMMENDED ELECTRIC STRIKE ✓
SIZE 100E	✓	AMSTERDAM / MONTREAL HANDHOLD 1000 mm, RECOMMENDED ELECTRIC STRIKE ✓
DOOR SHORTENING (10, 20, 30, 40 mm)	✓	AMSTERDAM / MONTREAL HANDHOLD 1500 mm WITH PUSHBUTTON, WITH DOOR LEAF ADJUSTMENT, ELECTRIC STRIKE REQUIRED ✓
TWO-COLOR DOOR	✓	AMSTERDAM / MONTREAL HANDHOLD 1000 mm WITH PUSHBUTTON, WITH DOOR LEAF ADJUSTMENT, ELECTRIC STRIKE REQUIRED ✓
CLASS 6 LOCK INSERTS, ONE KEY SYSTEM	✓	ELECTRIC STRIKE WITH DAY / NIGHT FEATURE ✓
UPPER ESCUTCHEON PROTECTION (THERMO PREMIUM)	✓	REED SWITCH ✓
KNOB-HANDLE	✓	TEDEE SET ✓

* FIXED ALUMINUM ILLUMINATORS - PAGES 88-89, FULL EQUIPMENT LIST - PAGES 94-99

GLASS



MATTE



MIRA STAR (MIRROR GLASS)

DOOR COLORS

ALPINE WALNUT



FRR

MAHOGANY



FMA

BRAZILIAN WALNUT



FRB

LIGHT WALNUT



FRP

GOLD OAK



FDE

WINCHESTER



FDW

LIGHT WENGE



FEJ

WHITE



FSB

STEEL GRAY



FKZ

ANTHRACITE



FKG

DARK ANTHRACITE



FKF

BLACK



FKC



KWHB BAMBERG 3 B



KWI BAMBERG 4



INTERNAL SIDE

THERMO PRIME 75 DOOR CONFIGURATION



KWF BAMBERG 1



INTERNAL SIDE

FITTINGS

HANDLE-HANDLE



THERMO PRIME

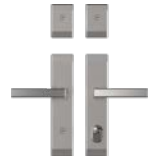

THERMO PREMIUM

HANDLE-KNOB



THERMO PRIME



THERMO PREMIUM

HANDHOLD



□ AMSTERDAM
○ MONTREAL

FITTING COLORS

ANODED PLATINUM



ANODED SILVER



ANODED BLACK



DOOR COLORS

ALPINE WALNUT



FRR

MAHOGANY



FMA

BRAZILIAN WALNUT



FRB

LIGHT WALNUT



FRP

GOLD OAK



FDE

WINCHESTER



FDW

LIGHT WENGE



FEJ

WHITE



FSB

STEEL GRAY



FKZ

ANTHRACITE



FKG

DARK ANTHRACITE



FKF

BLACK



FKC



KWJB ULM 1 B



KWK ULM 2

SIZE	80	90N	90E	100E
------	----	-----	-----	------

MODEL	THERMO PREMIUM 60	THERMO PREMIUM 75	THERMO PRIME 75
KWJ / KWJB ULM 1	✓	✓	-
KWK / KWKB ULM 2	✓	✓	✓

RC2 STANDARD EQUIPMENT

- GLAZED DOOR LEAF, COMPLIANT WITH THE "CLEAN AIR" PROGRAM TERMS
- 4 DOOR LEAF UPSTANDS
- THERMO PREMIUM DUOTHERM / THERMO PRIME DOOR FRAME ALUTHERM PRIME DOOR FRAME
- 3D-ADJUSTABLE HINGES WITH CAPS IN FITTING COLORS
- WARM SILL
- FITTINGS SET WITH INSERT PROTECTION
- BERGEN ESCUTCHEONS WITH ALEX HANDLES
- CLASS 5 LOCK INSERTS, ONE KEY SYSTEM FOR THERMO PREMIUM DOORS

INSERTS **INOX** **BLACK**

SURCHARGES

CUSTOM HEIGHT (THERMO PRIME)	2150 - 2200 mm	✓
AVAILABLE COLORS: FRP, FDE, FDW, FKG, FKF	2250 - 2300 mm	✓
	2350 - 2400 mm	✓
ALUTHERM PREMIUM DOOR FRAME (THERMO PREMIUM DOOR)	✓	AMSTERDAM / MONTREAL HANDHOLD 1500 mm, RECOMMENDED ELECTRIC STRIKE ✓
SIZE 100E	✓	AMSTERDAM / MONTREAL HANDHOLD 1000 mm, RECOMMENDED ELECTRIC STRIKE ✓
DOOR SHORTENING (10, 20, 30, 40, 60, 80, 100 mm)	✓	AMSTERDAM / MONTREAL HANDHOLD 1500 mm WITH PUSHBUTTON, WITH DOOR LEAF ADJUSTMENT, ELECTRIC STRIKE REQUIRED ✓
TWO-COLOR DOOR	✓	AMSTERDAM / MONTREAL HANDHOLD 1000 mm WITH PUSHBUTTON, WITH DOOR LEAF ADJUSTMENT, ELECTRIC STRIKE REQUIRED ✓
CLASS 6 LOCK INSERTS, ONE KEY SYSTEM	✓	ELECTRIC STRIKE WITH DAY / NIGHT FEATURE ✓
UPPER ESCUTCHEON PROTECTION (THERMO PREMIUM)	✓	REED SWITCH ✓
KNOB-HANDLE	✓	TEDEE SET ✓

* FIXED ALUMINUM ILLUMINATORS - PAGES 88-89, FULL EQUIPMENT LIST - PAGES 94-99

GLASS



MATTE



MIRA STAR (MIRROR GLASS)



DOOR COLORS

ALPINE WALNUT



FRR

MAHOGANY



FMA

BRAZILIAN WALNUT



FRB

LIGHT WALNUT



FRP

GOLD OAK



FDE

WINCHESTER



FDW

LIGHT WENGE



FEJ

WHITE



FSB

STEEL GRAY



FKZ

ANTHRACITE



FKG

DARK ANTHRACITE



FKF

BLACK



FKC



KWJ ULM 2

THERMO PRIME 75 DOOR CONFIGURATION



INTERNAL SIDE

INTERNAL SIDE

FITTINGS

HANDLE-HANDLE



THERMO PRIME



THERMO PREMIUM

HANDLE-KNOB



THERMO PRIME



THERMO PREMIUM

HANDHOLD



- AMSTERDAM
- MONTREAL

FITTING COLORS

ANODED PLATINUM



ANODED SILVER



ANODED BLACK



DOOR COLORS

ALPINE WALNUT



MAHOGANY



BRAZILIAN WALNUT



LIGHT WALNUT



GOLD OAK



WINCHESTER



LIGHT WENGE



WHITE



STEEL GRAY



ANTHRACITE



DARK ANTHRACITE



BLACK





KWL TREWIR 1



KWMB TREWIR 2 B

SIZE	80	90N	90E	100E
------	----	-----	-----	------

MODEL	THERMO PREMIUM 60	THERMO PREMIUM 75	THERMO PRIME 75
KWL / KWL B TREWIR 1	✓	✓	✓
KWM / KWMB TREWIR 2	✓	✓	✓
KWN / KWNB TREWIR 3	✓	✓	✓
KWP / KWPB TREWIR 4	✓	✓	✓
KW7 / KW7B TREWIR 7	✓	✓	✓

RC2 STANDARD EQUIPMENT

- GLAZED DOOR LEAF, COMPLIANT WITH THE "CLEAN AIR" PROGRAM TERMS
 - 4 DOOR LEAF UPSTANDS
 - THERMO PREMIUM DUOTHERM / THERMO PRIME DOOR FRAME ALUTHERM PRIME DOOR FRAME
 - 3D-ADJUSTABLE HINGES WITH CAPS IN FITTING COLORS
 - WARM SILL
 - FITTINGS SET WITH INSERT PROTECTION
 - BERGEN ESCUTCHEONS WITH ALEX HANDLES
 - CLASS 5 LOCK INSERTS, ONE KEY SYSTEM FOR THERMO PREMIUM DOORS
- INSERTS **INOX** **BLACK**

SURCHARGES

CUSTOM HEIGHT (THERMO PRIME)	2150 - 2200 mm	✓
AVAILABLE COLORS: FRP, FDE, FDW, FKG, FKF	2250 - 2300 mm	✓
	2350 - 2400 mm	✓
ALUTHERM PREMIUM DOOR FRAME (THERMO PREMIUM DOOR)	✓	AMSTERDAM / MONTREAL HANDHOLD 1500 mm, RECOMMENDED ELECTRIC STRIKE ✓
SIZE 100E	✓	AMSTERDAM / MONTREAL HANDHOLD 1000 mm, RECOMMENDED ELECTRIC STRIKE ✓
DOOR SHORTENING (10, 20, 30, 40 mm)	✓	AMSTERDAM / MONTREAL HANDHOLD 1500 mm WITH PUSHBUTTON, WITH DOOR LEAF ADJUSTMENT, ELECTRIC STRIKE REQUIRED ✓
TWO-COLOR DOOR	✓	AMSTERDAM / MONTREAL HANDHOLD 1000 mm WITH PUSHBUTTON, WITH DOOR LEAF ADJUSTMENT, ELECTRIC STRIKE REQUIRED ✓
CLASS 6 LOCK INSERTS, ONE KEY SYSTEM	✓	ELECTRIC STRIKE WITH DAY / NIGHT FEATURE ✓
UPPER ESCUTCHEON PROTECTION (THERMO PREMIUM)	✓	REED SWITCH ✓
KNOB-HANDLE	✓	TEDEE SET ✓

* FIXED ALUMINUM ILLUMINATORS - PAGES 88-89, FULL EQUIPMENT LIST - PAGES 94-99

GLASS



MATTE



GRAPHITE



MIRA STAR (MIRROR GLASS)

DOOR COLORS

ALPINE WALNUT



FRR

MAHOGANY



FMA

BRAZILIAN WALNUT



FRB

LIGHT WALNUT



FRP

GOLD OAK



FDE

WINCHESTER



FDW

LIGHT WENGE



FEJ

WHITE



FSB

STEEL GRAY



FKZ

ANTHRACITE



FKG

DARK ANTHRACITE



FKF

BLACK



FKC



KWN TREWIR 3



KWP TREWIR 4



KW7 TREWIR 7

THERMO PRIME 75 DOOR CONFIGURATION



KWL TREWIR 1



INTERNAL SIDE

FITTINGS

HANDLE-HANDLE



THERMO PRIME



THERMO PREMIUM

HANDLE-KNOB



THERMO PRIME



THERMO PREMIUM

HANDHOLD

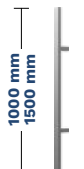

□ AMSTERDAM
○ MONTREAL

FITTING COLORS

ANODED PLATINUM



ANODED SILVER



ANODED BLACK



DOOR COLORS

ALPINE WALNUT



MAHOGANY



BRAZILIAN WALNUT



LIGHT WALNUT



GOLD OAK



WINCHESTER



LIGHT WENGE



WHITE



STEEL GRAY



ANTHRACITE



DARK ANTHRACITE



BLACK





KWSB DORFEN B

SIZE	80	90N	90E	100E
MODEL	THERMO PREMIUM 60		THERMO PREMIUM 75	
KWS / KWSB DORFEN	✓	✓	✓	

RC2 STANDARD EQUIPMENT

- GLAZED DOOR LEAF, COMPLIANT WITH THE "CLEAN AIR" PROGRAM TERMS
 - 4 DOOR LEAF UPSTANDS
 - THERMO PREMIUM DUOTHERM / THERMO PRIME DOOR FRAME ALUTHERM PRIME DOOR FRAME
 - 3D-ADJUSTABLE HINGES WITH CAPS IN FITTING COLORS
 - WARM SILL
 - FITTINGS SET WITH INSERT PROTECTION
 - BERGEN ESCUTCHEONS WITH ALEX HANDLES
 - CLASS 5 LOCK INSERTS, ONE KEY SYSTEM FOR THERMO PREMIUM DOORS
- INSERTS **INOX** **BLACK**

SURCHARGES

CUSTOM HEIGHT (THERMO PRIME)	2150 - 2200 mm	✓
AVAILABLE COLORS: FRP, FDE, FDW, FKG, FKF	2250 - 2300 mm	✓
	2350 - 2400 mm	✓
ALUTHERM PREMIUM DOOR FRAME (THERMO PREMIUM DOOR)	✓	AMSTERDAM / MONTREAL HANDHOLD 1500 mm, RECOMMENDED ELECTRIC STRIKE ✓
SIZE 100E	✓	AMSTERDAM / MONTREAL HANDHOLD 1000 mm, RECOMMENDED ELECTRIC STRIKE ✓
DOOR SHORTENING (10, 20, 30, 40 mm)	✓	AMSTERDAM / MONTREAL HANDHOLD 1500 mm WITH PUSHBUTTON, WITH DOOR LEAF ADJUSTMENT, ELECTRIC STRIKE REQUIRED ✓
TWO-COLOR DOOR	✓	AMSTERDAM / MONTREAL HANDHOLD 1000 mm WITH PUSHBUTTON, WITH DOOR LEAF ADJUSTMENT, ELECTRIC STRIKE REQUIRED ✓
CLASS 6 LOCK INSERTS, ONE KEY SYSTEM	✓	ELECTRIC STRIKE WITH DAY / NIGHT FEATURE ✓
UPPER ESCUTCHEON PROTECTION (THERMO PREMIUM)	✓	REED SWITCH ✓
KNOB-HANDLE	✓	TEDEE SET ✓

* FIXED ALUMINUM ILLUMINATORS - PAGES 88-89, FULL EQUIPMENT LIST - PAGES 94-99

GLASS



MATTE

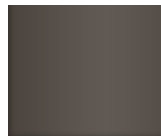

GRAPHITE



MIRA STAR (MIRROR GLASS)

DOOR COLORS

ALPINE WALNUT



FRR

MAHOGANY



FMA

BRAZILIAN WALNUT



FRB

LIGHT WALNUT



FRP

GOLD OAK



FDE

WINCHESTER



FDW

LIGHT WENGE



FEJ

WHITE



FSB

STEEL GRAY



FKZ

ANTHRACITE



FKG

DARK ANTHRACITE



FKF

BLACK



FKC



KWS DORFEN

THERMO PRIME 75 DOOR CONFIGURATION



INTERNAL SIDE

INTERNAL SIDE

FITTINGS

HANDLE-HANDLE



THERMO PRIME

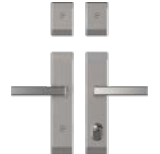

THERMO PREMIUM

HANDLE-KNOB



THERMO PRIME



THERMO PREMIUM

HANDHOLD



- AMSTERDAM**
- MONTREAL**

FITTING COLORS

ANODED PLATINUM



ANODED SILVER



ANODED BLACK



DOOR COLORS

ALPINE WALNUT



MAHOGANY



BRAZILIAN WALNUT



LIGHT WALNUT



GOLD OAK



WINCHESTER



LIGHT WENGE



WHITE



STEEL GRAY



ANTHRACITE



DARK ANTHRACITE



BLACK





KWT KASSEL 1



KWXB KASSEL 2 B

SIZE	80	90N	90E	100E
------	----	-----	-----	------

MODEL	THERMO PREMIUM 60	THERMO PREMIUM 75	THERMO PRIME 75
KWT / KWTB KASSEL 1	✓	✓	✓
KWX / KWXB KASSEL 2	✓	✓	✓

RC2 STANDARD EQUIPMENT

- GLAZED DOOR LEAF, COMPLIANT WITH THE "CLEAN AIR" PROGRAM TERMS
- 4 DOOR LEAF UPSTANDS
- THERMO PREMIUM DUOTHERM / THERMO PRIME DOOR FRAME ALUTHERM PRIME DOOR FRAME
- 3D-ADJUSTABLE HINGES WITH CAPS IN FITTING COLORS
- WARM SILL
- FITTINGS SET WITH INSERT PROTECTION
- BERGEN ESCUTCHEONS WITH ALEX HANDLES
- CLASS 5 LOCK INSERTS, ONE KEY SYSTEM FOR THERMO PREMIUM DOORS

- INSERTS **INOX** **BLACK**

SURCHARGES

CUSTOM HEIGHT (THERMO PRIME)	2150 - 2200 mm	✓
AVAILABLE COLORS: FRP, FDE, FDW, FKG, FKF	2250 - 2300 mm	✓
	2350 - 2400 mm	✓
ALUTHERM PREMIUM DOOR FRAME (THERMO PREMIUM DOOR)	✓	AMSTERDAM / MONTREAL HANDHOLD 1500 mm, RECOMMENDED ELECTRIC STRIKE ✓
SIZE 100E	✓	AMSTERDAM / MONTREAL HANDHOLD 1000 mm, RECOMMENDED ELECTRIC STRIKE ✓
DOOR SHORTENING (10, 20, 30, 40 mm)	✓	AMSTERDAM / MONTREAL HANDHOLD 1500 mm WITH PUSHBUTTON, WITH DOOR LEAF ADJUSTMENT, ELECTRIC STRIKE REQUIRED ✓
TWO-COLOR DOOR	✓	AMSTERDAM / MONTREAL HANDHOLD 1000 mm WITH PUSHBUTTON, WITH DOOR LEAF ADJUSTMENT, ELECTRIC STRIKE REQUIRED ✓
CLASS 6 LOCK INSERTS, ONE KEY SYSTEM	✓	ELECTRIC STRIKE WITH DAY / NIGHT FEATURE ✓
UPPER ESCUTCHEON PROTECTION (THERMO PREMIUM)	✓	REED SWITCH ✓
KNOB-HANDLE	✓	TEDEE SET ✓

* FIXED ALUMINUM ILLUMINATORS - PAGES 88-89, FULL EQUIPMENT LIST - PAGES 94-99

GLASS



MATTE



GRAPHITE



MIRA STAR (MIRROR GLASS)

DOOR COLORS

ALPINE WALNUT



FRR

MAHOGANY



FMA

BRAZILIAN WALNUT



FRB

LIGHT WALNUT



FRP

GOLD OAK



FDE

WINCHESTER



FDW

LIGHT WENGE



FEJ

WHITE



FSB

STEEL GRAY



FKZ

ANTHRACITE



FKG

DARK ANTHRACITE



FKF

BLACK



FKC



KWT KASSEL 1

THERMO PRIME 75 DOOR CONFIGURATION



INTERNAL SIDE

INTERNAL SIDE

FITTINGS

HANDLE-HANDLE



THERMO PRIME



THERMO PREMIUM

HANDLE-KNOB



THERMO PRIME



THERMO PREMIUM

HANDHOLD

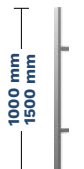

- AMSTERDAM**
- MONTREAL**

FITTING COLORS

ANODED PLATINUM



ANODED SILVER



ANODED BLACK



DOOR COLORS

ALPINE WALNUT



FRR

MAHOGANY



FMA

BRAZILIAN WALNUT



FRB

LIGHT WALNUT



FRP

GOLD OAK



FDE

WINCHESTER



FDW

LIGHT WENGE



FEJ

WHITE



FSB

STEEL GRAY



FKZ

ANTHRACITE



FKG

DARK ANTHRACITE



FKF

BLACK



FKC



KPN KRONACH 1



KPPB KRONACH 2 B

SIZE	80	90N	90E	100E
------	----	-----	-----	------

MODEL	THERMO PREMIUM 60	THERMO PREMIUM 75	THERMO PRIME 75
KPN / KPNB KRONACH 1	✓	✓	✓
KPP / KPPB KRONACH 2	✓	✓	✓
KPT / KPTB KRONACH 3	✓	✓	-
KPZ / KPZB KRONACH 4	✓	✓	-

RC2 STANDARD EQUIPMENT

- DOOR LEAF, COMPLIANT WITH THE "CLEAN AIR" PROGRAM TERMS
- 4 DOOR LEAF UPSTANDS
- THERMO PREMIUM DUOTHERM / THERMO PRIME DOOR FRAME ALUTHERM PRIME DOOR FRAME
- 3D-ADJUSTABLE HINGES WITH CAPS IN FITTING COLORS
- WARM SILL
- FITTINGS SET WITH INSERT PROTECTION
- BERGEN ESCUTCHEONS WITH ALEX HANDLES
- CLASS 5 LOCK INSERTS, ONE KEY SYSTEM FOR THERMO PREMIUM DOORS

- INSERTS **INOX** **BLACK**

SURCHARGES

CUSTOM HEIGHT (THERMO PRIME)	2150 - 2200 mm	✓
AVAILABLE COLORS: FRP, FDE, FDW, FKG, FKF	2250 - 2300 mm	✓
	2350 - 2400 mm	✓
ALUTHERM PREMIUM DOOR FRAME (THERMO PREMIUM DOOR)	✓	AMSTERDAM / MONTREAL HANDHOLD 1500 mm, RECOMMENDED ELECTRIC STRIKE ✓
SIZE 100E	✓	AMSTERDAM / MONTREAL HANDHOLD 1000 mm, RECOMMENDED ELECTRIC STRIKE ✓
RC3 PACKAGE	✓	AMSTERDAM / MONTREAL HANDHOLD 1500 mm WITH PUSHBUTTON, WITH DOOR LEAF ADJUSTMENT, ELECTRIC STRIKE REQUIRED ✓
TWO-COLOR DOOR	✓	AMSTERDAM / MONTREAL HANDHOLD 1000 mm WITH PUSHBUTTON, WITH DOOR LEAF ADJUSTMENT, ELECTRIC STRIKE REQUIRED ✓
DOOR SHORTENING (10, 20, 30, 40 mm)	✓	ELECTRIC STRIKE WITH DAY / NIGHT FEATURE ✓
CLASS 6 LOCK INSERTS, ONE KEY SYSTEM	✓	HIDDEN DOOR CLOSER (THERMO PREMIUM) ✓
UPPER ESCUTCHEON PROTECTION (THERMO PREMIUM)	✓	REED SWITCH ✓
KNOB-HANDLE	✓	TEDEE SET ✓
INSERT AND APPLICATION - OPPOSITE SIDE	✓	INSERT - OPPOSITE SIDE ✓

* FIXED ALUMINUM ILLUMINATORS - PAGES 88-89, FULL EQUIPMENT LIST - PAGES 94-99

DOOR COLORS

ALPINE WALNUT



FRR

MAHOGANY



FMA

BRAZILIAN WALNUT



FRB

LIGHT WALNUT



FRP

GOLD OAK



FDE

WINCHESTER



FDW

LIGHT WENGE



FEJ

WHITE



FSB

STEEL GRAY



FKZ

ANTHRACITE



FKG

DARK ANTHRACITE



FKF

BLACK



FKC



KPT KRONACH 3



KPZ KRONACH 4



INTERNAL SIDE

THERMO PRIME 75 DOOR CONFIGURATION



KPN KRONACH 1



INTERNAL SIDE

FITTINGS

HANDLE-HANDLE



THERMO PRIME



THERMO PREMIUM

HANDLE-KNOB



THERMO PRIME



THERMO PREMIUM

HANDHOLD



□ AMSTERDAM
○ MONTREAL

FITTING COLORS

ANODED PLATINUM



ANODED SILVER



ANODED BLACK



DOOR COLORS

ALPINE WALNUT



MAHOGANY



BRAZILIAN WALNUT



LIGHT WALNUT



GOLD OAK



WINCHESTER



LIGHT WENGE



WHITE



STEEL GRAY



ANTHRACITE



DARK ANTHRACITE



BLACK





KPJ REGEN 1



KPK REGEN 2

SIZE	80	90N	90E	100E
------	----	-----	-----	------

MODEL	THERMO PREMIUM 60	THERMO PREMIUM 75	THERMO PRIME 75
KPJ / KPJB REGEN 1	✓	✓	✓
KPK / KPKB REGEN 2	✓	✓	✓
KPL / KPLB REGEN 3	✓	✓	✓
KPS / KPSB REGEN 4	✓	✓	✓
KPM / KPMB REGEN 5	✓	✓	✓
KPR / KPRB REGEN 6	✓	✓	✓

RC2 STANDARD EQUIPMENT

- DOOR LEAF, COMPLIANT WITH THE "CLEAN AIR" PROGRAM TERMS
 - 4 DOOR LEAF UPSTANDS
 - THERMO PREMIUM DUOTHERM / THERMO PRIME DOOR FRAME ALUTHERM PRIME DOOR FRAME
 - 3D-ADJUSTABLE HINGES WITH CAPS IN FITTING COLORS
 - WARM SILL
 - FITTINGS SET WITH INSERT PROTECTION
 - BERGEN ESCUTCHEONS WITH ALEX HANDLES
 - CLASS 5 LOCK INSERTS, ONE KEY SYSTEM FOR THERMO PREMIUM DOORS
- INSERTS **INOX** **BLACK**

SURCHARGES

CUSTOM HEIGHT (THERMO PRIME)		2150 - 2200 mm	✓
AVAILABLE COLORS: FRP, FDE, FDW, FKG, FKF		2250 - 2300 mm	✓
		2350 - 2400 mm	✓
ALUTHERM PREMIUM DOOR FRAME (THERMO PREMIUM DOOR)	✓	AMSTERDAM / MONTREAL HANDHOLD 1500 mm, RECOMMENDED ELECTRIC STRIKE	✓
SIZE 100E	✓	AMSTERDAM / MONTREAL HANDHOLD 1000 mm, RECOMMENDED ELECTRIC STRIKE	✓
RC3 PACKAGE	✓	AMSTERDAM / MONTREAL HANDHOLD 1500 mm WITH PUSHBUTTON, WITH DOOR LEAF ADJUSTMENT, ELECTRIC STRIKE REQUIRED	✓
TWO-COLOR DOOR	✓	AMSTERDAM / MONTREAL HANDHOLD 1000 mm WITH PUSHBUTTON, WITH DOOR LEAF ADJUSTMENT, ELECTRIC STRIKE REQUIRED	✓
DOOR SHORTENING (10, 20, 30, 40 mm)	✓	ELECTRIC STRIKE WITH DAY / NIGHT FEATURE	✓
CLASS 6 LOCK INSERTS, ONE KEY SYSTEM	✓	HIDDEN DOOR CLOSER (THERMO PREMIUM)	✓
UPPER ESCUTCHEON PROTECTION (THERMO PREMIUM)	✓	REED SWITCH	✓
KNOB-HANDLE	✓	TEDEE SET	✓
INSERT AND APPLICATION - OPPOSITE SIDE	✓	INSERT - OPPOSITE SIDE	✓

* FIXED ALUMINUM ILLUMINATORS - PAGES 88-89, FULL EQUIPMENT LIST - PAGES 94-99

DOOR COLORS

ALPINE WALNUT



FRR

MAHOGANY



FMA

BRAZILIAN WALNUT



FRB

LIGHT WALNUT



FRP

GOLD OAK



FDE

WINCHESTER



FDW

LIGHT WENGE



FEJ

WHITE



FSB

STEEL GRAY



FKZ

ANTHRACITE



FKG

DARK ANTHRACITE



FKF

BLACK



FKC



KPL REGEN 3



KPS REGEN 4



KPM REGEN 5

THERMO PRIME 75 DOOR CONFIGURATION



KPRB REGEN 6 B



KPJ REGEN 1



INTERNAL SIDE

FITTINGS

HANDLE-HANDLE



THERMO PRIME



THERMO PREMIUM

HANDLE-KNOB



THERMO PRIME



THERMO PREMIUM

HANDHOLD



□ AMSTERDAM
○ MONTREAL

FITTING COLORS

ANODED PLATINUM



ANODED SILVER



ANODED BLACK



DOOR COLORS

ALPINE WALNUT



MAHOGANY



BRAZILIAN WALNUT



LIGHT WALNUT



GOLD OAK



WINCHESTER



LIGHT WENGE



WHITE



STEEL GRAY



ANTHRACITE



DARK ANTHRACITE



BLACK





KPE DREZNO 1



KPFB DREZNO 2 B

SIZE	80	90N	90E	100E
-------------	----	-----	-----	------

MODEL	THERMO PREMIUM 60	THERMO PREMIUM 75	THERMO PRIME 75
KPE / KPEB DREZNO 1	✓	✓	-
KPF / KPFB DREZNO 2	✓	✓	-
KPH / KPFB DREZNO 4	✓	✓	✓

RC2 STANDARD EQUIPMENT

- DOOR LEAF, COMPLIANT WITH THE "CLEAN AIR" PROGRAM TERMS
- 4 DOOR LEAF UPSTANDS
- THERMO PREMIUM DUOTHERM / THERMO PRIME DOOR FRAME ALUTHERM PRIME DOOR FRAME
- 3D-ADJUSTABLE HINGES WITH CAPS IN FITTING COLORS
- INSERTS **INOX** **BLACK**
- WARM SILL
- FITTINGS SET WITH INSERT PROTECTION
- BERGEN ESCUTCHEONS WITH ALEX HANDLES
- CLASS 5 LOCK INSERTS, ONE KEY SYSTEM FOR THERMO PREMIUM DOORS

SURCHARGES

CUSTOM HEIGHT (THERMO PRIME)	2150 - 2200 mm	✓
AVAILABLE COLORS: FRP, FDE, FDW, FKG, FKF	2250 - 2300 mm	✓
	2350 - 2400 mm	✓
ALUTHERM PREMIUM DOOR FRAME (THERMO PREMIUM DOOR)	✓	AMSTERDAM / MONTREAL HANDHOLD 1500 mm, RECOMMENDED ELECTRIC STRIKE ✓
SIZE 100E	✓	AMSTERDAM / MONTREAL HANDHOLD 1000 mm, RECOMMENDED ELECTRIC STRIKE ✓
RC3 PACKAGE	✓	AMSTERDAM / MONTREAL HANDHOLD 1500 mm WITH PUSHBUTTON, WITH DOOR LEAF ADJUSTMENT, ELECTRIC STRIKE REQUIRED ✓
TWO-COLOR DOOR	✓	AMSTERDAM / MONTREAL HANDHOLD 1000 mm WITH PUSHBUTTON, WITH DOOR LEAF ADJUSTMENT, ELECTRIC STRIKE REQUIRED ✓
DOOR SHORTENING KPH (10, 20, 30, 40 mm), KPE, KPF, KPG (10, 20, 30, 40, 60, 80, 100 mm)	✓	ELECTRIC STRIKE WITH DAY / NIGHT FEATURE ✓
CLASS 6 LOCK INSERTS, ONE KEY SYSTEM	✓	HIDDEN DOOR CLOSER (THERMO PREMIUM) ✓
UPPER ESCUTCHEON PROTECTION (THERMO PREMIUM)	✓	REED SWITCH ✓
KNOB-HANDLE	✓	TEDEE SET ✓
INSERT - OPPOSITE SIDE	✓	

* FIXED ALUMINUM ILLUMINATORS - PAGES 88-89, FULL EQUIPMENT LIST - PAGES 94-99

DOOR COLORS

ALPINE WALNUT



FRR

MAHOGANY



FMA

BRAZILIAN WALNUT



FRB

LIGHT WALNUT



FRP

GOLD OAK



FDE

WINCHESTER



FDW

LIGHT WENGE



FEJ

WHITE



FSB

STEEL GRAY



FKZ

ANTHRACITE



FKG

DARK ANTHRACITE



FKF

BLACK



FKC



KPH DREZNO 4



INTERNAL SIDE

THERMO PRIME 75 DOOR CONFIGURATION



KPE DREZNO 4



INTERNAL SIDE

FITTINGS

HANDLE-HANDLE



THERMO PRIME



THERMO PREMIUM

HANDLE-KNOB



THERMO PRIME



THERMO PREMIUM

HANDHOLD



□ AMSTERDAM
○ MONTREAL

FITTING COLORS

ANODED PLATINUM



ANODED SILVER



ANODED BLACK



DOOR COLORS

ALPINE WALNUT



MAHOGANY



BRAZILIAN WALNUT



LIGHT WALNUT



GOLD OAK



WINCHESTER



LIGHT WENGE



WHITE



STEEL GRAY



ANTHRACITE



DARK ANTHRACITE



BLACK





KPAB ERFURT 1 B



KPB ERFURT 2

SIZE	80	90N	90E	100E
------	----	-----	-----	------

MODEL	THERMO PREMIUM 60	THERMO PREMIUM 75	THERMO PRIME 75
KPA / KPAB ERFURT 1	✓	✓	✓
KPB / KPBB ERFURT 2	✓	✓	✓
KPC / KPCB ERFURT 3	✓	✓	✓

RC2 STANDARD EQUIPMENT

- DOOR LEAF, COMPLIANT WITH THE "CLEAN AIR" PROGRAM TERMS
- 4 DOOR LEAF UPSTANDS
- THERMO PREMIUM DUOTHERM / THERMO PRIME DOOR FRAME ALUTHERM PRIME DOOR FRAME
- 3D-ADJUSTABLE HINGES WITH CAPS IN FITTING COLORS
- INSERTS **INOX** **BLACK**
- WARM SILL
- FITTINGS SET WITH INSERT PROTECTION
- BERGEN ESCUTCHEONS WITH ALEX HANDLES
- CLASS 5 LOCK INSERTS, ONE KEY SYSTEM FOR THERMO PREMIUM DOORS

SURCHARGES

CUSTOM HEIGHT (THERMO PRIME)	2150 - 2200 mm	✓
AVAILABLE COLORS: FRP, FDE, FDW, FKG, FKF	2250 - 2300 mm	✓
	2350 - 2400 mm	✓
ALUTHERM PREMIUM DOOR FRAME (THERMO PREMIUM DOOR)	✓	AMSTERDAM / MONTREAL HANDHOLD 1500 mm, RECOMMENDED ELECTRIC STRIKE ✓
SIZE 100E	✓	AMSTERDAM / MONTREAL HANDHOLD 1000 mm, RECOMMENDED ELECTRIC STRIKE ✓
RC3 PACKAGE	✓	AMSTERDAM / MONTREAL HANDHOLD 1500 mm WITH PUSHBUTTON, WITH DOOR LEAF ADJUSTMENT, ELECTRIC STRIKE REQUIRED ✓
TWO-COLOR DOOR	✓	AMSTERDAM / MONTREAL HANDHOLD 1000 mm WITH PUSHBUTTON, WITH DOOR LEAF ADJUSTMENT, ELECTRIC STRIKE REQUIRED ✓
DOOR SHORTENING (10, 20, 30, 40 mm)	✓	ELECTRIC STRIKE WITH DAY / NIGHT FEATURE ✓
CLASS 6 LOCK INSERTS, ONE KEY SYSTEM	✓	HIDDEN DOOR CLOSER (THERMO PREMIUM) ✓
UPPER ESCUTCHEON PROTECTION (THERMO PREMIUM)	✓	REED SWITCH ✓
KNOB-HANDLE	✓	TEDEE SET ✓
INSERT - OPPOSITE SIDE	✓	

* FIXED ALUMINUM ILLUMINATORS - PAGES 88-89, FULL EQUIPMENT LIST - PAGES 94-99

DOOR COLORS

ALPINE WALNUT



FRR

MAHOGANY



FMA

BRAZILIAN WALNUT



FRB

LIGHT WALNUT



FRP

GOLD OAK



FDE

WINCHESTER



FDW

LIGHT WENGE



FEJ

WHITE



FSB

STEEL GRAY



FKZ

ANTHRACITE



FKG

DARK ANTHRACITE



FKF

BLACK



FKC



KPC ERFURT 3



INTERNAL SIDE

THERMO PRIME 75 DOOR CONFIGURATION



KPA ERFURT 1



INTERNAL SIDE

FITTINGS

HANDLE-HANDLE



THERMO PRIME



THERMO PREMIUM

HANDLE-KNOB



THERMO PRIME



THERMO PREMIUM

HANDHOLD



□ AMSTERDAM
○ MONTREAL

FITTING COLORS

ANODED PLATINUM



ANODED SILVER



ANODED BLACK



DOOR COLORS

ALPINE WALNUT



FRR

MAHOGANY



FMA

BRAZILIAN WALNUT



FRB

LIGHT WALNUT



FRP

GOLD OAK



FDE

WINCHESTER



FDW

LIGHT WENGE



FEJ

WHITE



FSB

STEEL GRAY



FKZ

ANTHRACITE



FKG

DARK ANTHRACITE



FKF

BLACK



FKC

ELITE 3D

BRIG / OLTEN / VISP / TRIN / BERNO



ELA BRIG



ELB OLTEN

SIZE	80	90N	90E	100E
------	----	-----	-----	------

MODEL	THERMO PREMIUM 60	THERMO PREMIUM 75	THERM PRIME 75
ELA BRIG	✓	✓	✓
ELB OLTEN	✓	✓	✓
ELC VISP	✓	✓	✓
ELD TRIN	✓	✓	✓
ELE BERNO	✓	✓	✓

RC2 STANDARD EQUIPMENT

- DOOR LEAF, COMPLIANT WITH THE "CLEAN AIR" PROGRAM TERMS
- 4 DOOR LEAF UPSTANDS
- THERMO PREMIUM DUOTHERM / THERMO PRIME DOOR FRAME ALUTHERM PRIME DOOR FRAME
- 3D-ADJUSTABLE HINGES WITH CAPS IN FITTING COLORS
- WARM SILL
- FITTINGS SET WITH INSERT PROTECTION
- BERGEN ESCUTCHEONS WITH ALEX HANDLES
- CLASS 5 LOCK INSERTS, ONE KEY SYSTEM FOR THERMO PREMIUM DOORS

SURCHARGES

CUSTOM HEIGHT (THERMO PRIME)		2150 - 2200 mm	✓
AVAILABLE COLORS: FRP, FDE, FDW, FKG, FKF		2250 - 2300 mm	✓
		2350 - 2400 mm	✓
ALUTHERM PREMIUM DOOR FRAME (THERMO PREMIUM DOOR)	✓	NOB-HANDLE	✓
SIZE 100E	✓	HIDDEN DOOR CLOSER (THERMO PREMIUM)	✓
RC3 PACKAGE	✓	REED SWITCH	✓
DOOR SHORTENING (10, 20, 30, 40 mm)	✓	ELECTRIC STRIKE WITH DAY / NIGHT FEATURE	✓
TWO-COLOR DOOR	✓	PANEL ON THE OTHER SIDE	✓
CLASS 6 LOCK INSERTS, ONE KEY SYSTEM	✓	TEDEE SET	✓
UPPER ESCUTCHEON PROTECTION	✓		

* FIXED ALUMINUM ILLUMINATORS - PAGES 88-89, FULL EQUIPMENT LIST - PAGES 94-99

INSERT



CLASSIC



MODERN



DOOR COLORS

ALPINE WALNUT



LIGHT WENGE



MAHOGANY



WHITE



BRAZILIAN WALNUT



STEEL GRAY



LIGHT WALNUT



ANTHRACITE



GOLD OAK



DARK ANTHRACITE



WINCHESTER



BLACK



GERDA® ELITE 3D BRIG / OLTEN / VISP / TRIN / BERNO



ELC VISP



ELD TRIN



ELE BERNO

THERMO PRIME 75 DOOR CONFIGURATION



ELA BRIG



INTERNAL SIDE

FITTINGS

HANDLE-HANDLE



THERMO PRIME



THERMO PREMIUM

HANDLE-KNOB



THERMO PRIME



THERMO PREMIUM

FITTING COLORS

ANODED PLATINUM



ANODED SILVER



ANODED BLACK



DOOR COLORS

ALPINE WALNUT



FRR

MAHOGANY



FMA

BRAZILIAN WALNUT



FRB

LIGHT WALNUT



FRP

GOLD OAK



FDE

WINCHESTER



FDW

LIGHT WENGE



FEJ

WHITE



FSB

STEEL GRAY



FKZ

ANTHRACITE



FKG

DARK ANTHRACITE



FKF

BLACK



FKC



NS1B MILANO 8 B



NS2 MILANO 9

SIZE (THERMO PRIME, THERMO PREMIUM)	-	80	90N	90E	100E
SIZE OPTIMA	80N	80	90N	90E	100E

MODEL	OPTIMA 60	THERMO PREMIUM 60	THERMO PREMIUM 75	THERMO PRIME 75
NS1/NS1B MILANO 8	✓	✓	✓	✓
NS2/NS2B MILANO 9	✓	✓	✓	✓
NS3/NS3B MILANO 10	✓	✓	✓	✓
NS4/NS4B MILANO 11	✓	✓	✓	✓
NS9/NS9B MILANO 12	✓	✓	✓	✓

RC2 STANDARD EQUIPMENT

- GLAZED DOOR LEAF, COMPLIANT WITH THE "CLEAN AIR" PROGRAM TERMS
- 4 DOOR LEAF UPSTANDS THERMO PREMIUM AND THERMO PRIME, 3 DOOR LEAF UPSTANDS OPTIMA
- THERMO PREMIUM DUOTHERM / THERMO PRIME DOOR FRAME ALUTHERM PRIME DOOR FRAME / OPTIMA ERFOOTHERM DOOR FRAME
- 3D-ADJUSTABLE HINGES WITH CAPS IN FITTING COLORS THERMO PREMIUM AND THERMO PRIME, 2D HINGE WITH CAPS IN FITTING COLORS OPTIMA
- DOUBLE-SIDED PATTERN
- ALUMINUM SILL
- FITTINGS SET WITH INSERT PROTECTION
- BERGEN THERMO PREMIUM LONG ESCUTCHEONS, BERGEN THERMO PRIME SPLIT ESCUTCHEONS, BLOK OPTIMA SPLIT ESCUTCHEON
- CLASS 5 LOCK INSERTS, ONE KEY SYSTEM FOR THERMO PREMIUM AND OPTIMA DOORS

SURCHARGES

CUSTOM HEIGHT (THERMO PRIME)		2150 - 2200 mm	✓
AVAILABLE COLORS: FRP, FDE, FDW, FKG, FKF		2250 - 2300 mm	✓
		2350 - 2400 mm	✓
ALUTHERM PREMIUM DOOR FRAME (THERMO PREMIUM DOOR)	✓	AMSTERDAM / MONTREAL HANDHOLD 1500 mm, RECOMMENDED ELECTRIC STRIKE	✓
UPPER ESCUTCHEON PROTECTION (THERMO PREMIUM, OPTIMA)	✓	AMSTERDAM / MONTREAL HANDHOLD 1000 mm, RECOMMENDED ELECTRIC STRIKE	✓
DOOR SHORTENING NS1, NS2, NS3, NS9, (10, 20, 30, 40 mm), NS4 (10, 20, 30, 40, 60, 80, 100 mm)	✓	AMSTERDAM / MONTREAL HANDHOLD 1500 mm WITH PUSHBUTTON, WITH DOOR LEAF ADJUSTMENT, ELECTRIC STRIKE REQUIRED	✓
TWO-COLOR DOOR	✓	AMSTERDAM / MONTREAL HANDHOLD 1000 mm WITH PUSHBUTTON, WITH DOOR LEAF ADJUSTMENT, ELECTRIC STRIKE REQUIRED	✓
CLASS 6 LOCK INSERTS, ONE KEY SYSTEM	✓	ELECTRIC STRIKE WITH DAY / NIGHT FEATURE	✓
SIZE 100E	✓	HIDDEN DOOR CLOSER (THERMO PREMIUM)	✓
KNOB-HANDLE	✓	REED SWITCH	✓
		TEDEE SET	✓

* FIXED ALUMINUM ILLUMINATORS - PAGES 88-89, FULL EQUIPMENT LIST - PAGES 94-99

GLASS



MATTE

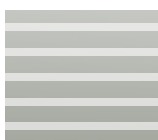

MATTE, SEE-THROUGH STRIPS



MIRA STAR (MIRROR GLASS)

DOOR COLORS

ALPINE WALNUT



FRR

MAHOGANY



FMA

BRAZILIAN WALNUT



FRB

LIGHT WALNUT



FRP

GOLD OAK



FDE

WINCHESTER



FDW

LIGHT WENGE



FEJ

WHITE



FSB

STEEL GRAY



FKZ

ANTHRACITE



FKG

DARK ANTHRACITE



FKF

BLACK



FKC



NS3 MILANO 10



NS4 MILANO 11



NS9 MILANO 12

THERMO PRIME 75 DOOR CONFIGURATION



NS1B MILANO 8 B



INTERNAL SIDE

FITTINGS

HANDLE-HANDLE



THERMO PRIME



THERMO PREMIUM



OPTIMA

HANDLE-KNOB



THERMO PREMIUM

HANDHOLD

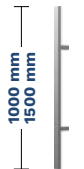

AMSTERDAM

MONTREAL

FITTING COLORS

ANODED PLATINUM



ANODED SILVER



ANODED BLACK



DOOR COLORS

ALPINE WALNUT



FRR

MAHOGANY



FMA

BRAZILIAN WALNUT



FRB

LIGHT WALNUT



FRP

GOLD OAK



FDE

WINCHESTER



FDW

LIGHT WENGE



FEJ

WHITE



FSB

STEEL GRAY



FKZ

ANTHRACITE



FKG

DARK ANTHRACITE



FKF

BLACK



FKC

TEMPO HANOVER / INNSBRUCK



NS5B HANOVER 5 B



NS6 HANOVER 6

SIZE (THERMO PRIME, THERMO PREMIUM)	-	80	90N	90E	100E
SIZE OPTIMA	80N	80	90N	90E	100E

MODEL	OPTIMA 60	THERMO PREMIUM 60	THERMO PREMIUM 75	THERMO PRIME 75
NS5 HANOVER 5 B	✓	✓	✓	✓
NS6 HANOVER 6	✓	✓	✓	✓
NS7 INNSBRUCK	✓	✓	✓	✓

RC2 STANDARD EQUIPMENT

- GLAZED DOOR LEAF, COMPLIANT WITH THE "CLEAN AIR" PROGRAM TERMS
- 4 DOOR LEAF UPSTANDS THERMO PREMIUM AND THERMO PRIME, 3 DOOR LEAF UPSTANDS OPTIMA
- THERMO PREMIUM DUOTHERM / THERMO PRIME DOOR FRAME ALUTHERM PRIME DOOR FRAME / OPTIMA DOOR FRAME PERFOTHERM
- 3D-ADJUSTABLE HINGES WITH CAPS IN FITTING COLORS THERMO PREMIUM AND THERMO PRIME, 2D HINGE WITH CAPS IN FITTING COLORS OPTIMA
- DOUBLE-SIDED PATTERN
- ALUMINUM SILL
- FITTINGS SET WITH INSERT PROTECTION
- BERGEN THERMO PREMIUM LONG ESCUTCHEONS, BERGEN THERMO PRIME SPLIT ESCUTCHEONS, BLOK OPTIMA SPLIT ESCUTCHEON
- CLASS 5 LOCK INSERTS, ONE KEY SYSTEM FOR THERMO PREMIUM AND OPTIMA DOORS

SURCHARGES

CUSTOM HEIGHT (THERMO PRIME)	2150 - 2200 mm	✓	
AVAILABLE COLORS: FRP, FDE, FDW, FKG, FKF	2250 - 2300 mm	✓	
	2350 - 2400 mm	✓	
ALUTHERM PREMIUM DOOR FRAME (THERMO PREMIUM DOOR)	✓	AMSTERDAM / MONTREAL HANDHOLD 1500 mm, RECOMMENDED ELECTRIC STRIKE	✓
SIZE 100E	✓	AMSTERDAM / MONTREAL HANDHOLD 1000 mm, RECOMMENDED ELECTRIC STRIKE	✓
DOOR SHORTENING NS5 (10, 20, 30, 40, 60, 80, 100 mm), NS6 (10, 20, 30, 40 mm)	✓	AMSTERDAM / MONTREAL HANDHOLD 1500 mm WITH PUSHBUTTON, WITH DOOR LEAF ADJUSTMENT, ELECTRIC STRIKE REQUIRED	✓
TWO-COLOR DOOR	✓	AMSTERDAM / MONTREAL HANDHOLD 1000 mm WITH PUSHBUTTON, WITH DOOR LEAF ADJUSTMENT, ELECTRIC STRIKE REQUIRED	✓
CLASS 6 LOCK INSERTS, ONE KEY SYSTEM	✓	ELECTRIC STRIKE WITH DAY / NIGHT FEATURE	✓
UPPER ESCUTCHEON PROTECTION (THERMO PREMIUM, OPTIMA)	✓	HIDDEN DOOR CLOSER (THERMO PREMIUM)	✓
KNOB-HANDLE	✓	REED SWITCH	✓
		TEDEE SET	✓

* FIXED ALUMINUM ILLUMINATORS - PAGES 88-89, FULL EQUIPMENT LIST - PAGES 94-99

GLASS



MATTE



MIRA STAR (MIRROR GLASS)

DOOR COLORS

ALPINE WALNUT



FRR

MAHOGANY



FMA

BRAZILIAN WALNUT



FRB

LIGHT WALNUT



FRP

GOLD OAK



FDE

WINCHESTER



FDW

LIGHT WENGE



FEJ

WHITE



FSB

STEEL GRAY



FKZ

ANTHRACITE



FKG

DARK ANTHRACITE



FKF

BLACK



FKC



NS7 INNSBRUCK

THERMO PRIME 75 DOOR CONFIGURATION



NS5B HANOVER 5 B



INTERNAL SIDE

FITTINGS

HANDLE-HANDLE



THERMO PRIME



THERMO PREMIUM



OPTIMA

HANDLE-KNOB



THERMO PREMIUM

HANDHOLD

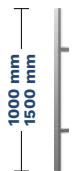

AMSTERDAM

MONTREAL

FITTING COLORS

ANODED PLATINUM



ANODED SILVER



ANODED BLACK



DOOR COLORS

ALPINE WALNUT



MAHOGANY



BRAZILIAN WALNUT



LIGHT WALNUT



GOLD OAK



WINCHESTER



LIGHT WENGE



WHITE



STEEL GRAY



ANTHRACITE



DARK ANTHRACITE



BLACK





W00 FLAT

SIZE (THERMO PRIME, THERMO PREMIUM)	-	80	90N	90E	100E
SIZE OPTIMA	80N	80	90N	90E	100E

MODEL	OPTIMA 50	OPTIMA 60	THERMO PREMIUM 60	THERMO PREMIUM 75	THERMO PRIME 75
W00 FLAT	✓	✓	✓	✓	✓

RC2 STANDARD EQUIPMENT

- DOOR LEAF COMPLIANT WITH THE "CLEAN AIR" PROGRAM TERMS
- ALUMINUM SILL
- 4 DOOR LEAF UPSTANDS THERMO PREMIUM AND THERMO PRIME, 3 DOOR LEAF UPSTANDS OPTIMA
- FITTINGS SET WITH INSERT PROTECTION
- THERMO PREMIUM DOOR FRAME DUOTHERM / THERMO PRIME DOOR FRAME ALUTHERM PRIME / OPTIMA 60 PERFOTHERM / OPTIMA 50 STEEL DOOR FRAME
- BERGEN THERMO PREMIUM LONG ESCUTCHEONS, BERGEN THERMO PRIME SPLIT ESCUTCHEONS, BLOK OPTIMA SPLIT ESCUTCHEON
- 3D-ADJUSTABLE HINGES WITH CAPS IN FITTING COLORS THERMO PREMIUM AND THERMO PRIME, 2D HINGE WITH CAPS IN FITTING COLORS OPTIMA
- CLASS 5 LOCK INSERTS, ONE KEY SYSTEM FOR THERMO PREMIUM AND OPTIMA DOORS

SURCHARGES

CUSTOM HEIGHT (THERMO PRIME)	2150 - 2200 mm	✓
AVAILABLE COLORS: FRP, FDE, FDW, FKG, FKF	2250 - 2300 mm	✓
	2350 - 2400 mm	✓
ALUTHERM PREMIUM DOOR FRAME (THERMO PREMIUM DOOR) / ALUTHERM (OPTIMA 60)	✓ AMSTERDAM / MONTREAL HANDHOLD 1500 mm	✓
OPTIMA 50 PERFOTHERM DOOR FRAME	✓ AMSTERDAM / MONTREAL HANDHOLD 1000 mm	✓
SIZE 100E	✓ AMSTERDAM / MONTREAL HANDHOLD 1500 mm WITH PUSHBUTTON, WITH DOOR LEAF ADJUSTMENT	✓
RC3 PACKAGE	✓ AMSTERDAM / MONTREAL HANDHOLD 1000 mm WITH PUSHBUTTON, WITH DOOR LEAF ADJUSTMENT	✓
DOOR SHORTENING (10, 20, 30, 40, 60, 80, 100 mm)	✓ ELECTRIC STRIKE WITH DAY / NIGHT FEATURE	✓
TWO-COLOR DOOR	✓ HIDDEN DOOR CLOSER (THERMO PRIME, THERMO PREMIUM)	✓
CLASS 6 LOCK INSERTS, ONE KEY SYSTEM	✓ REED SWITCH	✓
UPPER ESCUTCHEON PROTECTION (THERMO PREMIUM, OPTIMA)	✓ TEDEE SET	✓
KNOB-HANDLE	✓	

* FIXED ALUMINUM ILLUMINATORS – PAGES 88-89, FULL EQUIPMENT LIST – PAGES 94-99

DOOR COLORS

ALPINE WALNUT



FRR

MAHOGANY



FMA

BRAZILIAN WALNUT



FRB

LIGHT WALNUT



FRP

GOLD OAK



FDE

WINCHESTER



FDW

LIGHT WENGE



FEJ

WHITE



FSB

STEEL GRAY



FKZ

ANTHRACITE



FKG

DARK ANTHRACITE



FKF

BLACK



FKC



W00 FLAT



INTERNAL SIDE

THERMO PRIME 75 DOOR CONFIGURATION



W00 FLAT



INTERNAL SIDE

FITTINGS

HANDLE-HANDLE



THERMO PRIME



THERMO PREMIUM



OPTIMA

HANDLE-KNOB



THERMO PREMIUM

HANDHOLD



AMSTERDAM

MONTREAL

FITTING COLORS

ANODED PLATINUM



ANODED SILVER



ANODED BLACK



DOOR COLORS

ALPINE WALNUT



MAHOGANY



BRAZILIAN WALNUT



LIGHT WALNUT



GOLD OAK



WINCHESTER



LIGHT WENGE



WHITE



STEEL GRAY



ANTHRACITE



DARK ANTHRACITE



BLACK





SNU MILANO 4



SNUA MILANO 4A

SIZE (MILANO 4, MILANO 4A)	80N	80	90N	90E	100E
SIZE (MILANO 4B)	-	-	-	90E	-

MODEL	OPTIMA 50	OPTIMA 60
SNU MILANO 4	-	✓
SNUA MILANO 4A	-	✓
SNUB MILANO 4B	-	✓

RC2 STANDARD EQUIPMENT

- GLAZED DOOR LEAF, COMPLIANT WITH THE "CLEAN AIR" PROGRAM TERMS
- 3 DOOR LEAF UPSTANDS
- OPTIMA 60 PERFOTHERM DOOR FRAME
- 2D HINGE WITH CAPS IN FITTING COLORS
- DOUBLE-SIDED PATTERN
- ALUMINUM SILL
- FITTINGS SET WITH INSERT PROTECTION
- BERGEN AND BLOK SPLIT ESCUTCHEONS
- CLASS 5 LOCK INSERTS, ONE KEY SYSTEM

SURCHARGES

DOOR FRAME ALUTHERM OPTIMA	✓	AMSTERDAM / MONTREAL HANDHOLD 1500 mm, RECOMMENDED ELECTRIC STRIKE	✓
SIZE 100E	✓	AMSTERDAM / MONTREAL HANDHOLD 1000 mm, RECOMMENDED ELECTRIC STRIKE	✓
DOOR SHORTENING (10, 20, 30, 40, 60, 80, 100 mm)	✓	AMSTERDAM / MONTREAL HANDHOLD 1500 mm WITH PUSHBUTTON, WITH DOOR LEAF ADJUSTMENT, ELECTRIC STRIKE REQUIRED	✓
TWO-COLOR DOOR	✓	AMSTERDAM / MONTREAL HANDHOLD 1000 mm WITH PUSHBUTTON, WITH DOOR LEAF ADJUSTMENT, ELECTRIC STRIKE REQUIRED	✓
CLASS 6 LOCK INSERTS, ONE KEY SYSTEM	✓	ELECTRIC STRIKE WITH DAY / NIGHT FEATURE	✓
UPPER ESCUTCHEON PROTECTION	✓	REED SWITCH	✓
KNOB-HANDLE	✓	TEDEE SET	✓

* FIXED ALUMINUM ILLUMINATORS – PAGES 88-89, FULL EQUIPMENT LIST – PAGES 94-99

GLASS



MATTE



MATTE, SEE-THROUGH STRIPS



GRAPHITE



MIRA STAR (MIRROR GLASS)

DOOR COLORS

ALPINE WALNUT



FRR

MAHOGANY



FMA

BRAZILIAN WALNUT



FRB

LIGHT WALNUT



FRP

GOLD OAK



FDE

WINCHESTER



FDW

LIGHT WENGE



FEJ

WHITE



FSB

STEEL GRAY



FKZ

ANTHRACITE



FKG

DARK ANTHRACITE



FKF

BLACK



FKC



SNUB MILANO 4B

FITTINGS

HANDLE-HANDLE



HANDLE-KNOB

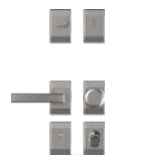

HANDHOLD

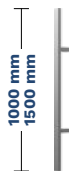

□ AMSTERDAM

○ MONTREAL

FITTING COLORS

ANODED PLATINUM



ANODED SILVER



ANODED BLACK



DOOR COLORS

ALPINE WALNUT



MAHOGANY



BRAZILIAN WALNUT



LIGHT WALNUT



GOLD OAK



WINCHESTER



LIGHT WENGE



WHITE



STEEL GRAY



ANTHRACITE



DARK ANTHRACITE



BLACK





NT1 TURYN 1



NT1B TURYN 1B

SIZE	80N	80	90N	90E	100E
------	-----	----	-----	-----	------

MODEL	OPTIMA 50	OPTIMA 60
NT1 TURYN 1	-	✓
NT1B TURYN 1B	-	✓
NT2 TURYN 2	-	✓
NT2B TURYN 2B	-	✓

RC2 STANDARD EQUIPMENT

• GLAZED DOOR LEAF, COMPLIANT WITH THE "CLEAN AIR" PROGRAM TERMS	• ALUMINUM SILL
• 3 DOOR LEAF UPSTANDS	• FITTINGS SET WITH INSERT PROTECTION
• OPTIMA 60 PERFOTHERM DOOR FRAME	• BERGEN AND BLOK SPLIT ESCUTCHEONS
• 2D HINGE WITH CAPS IN FITTING COLORS	• CLASS 5 LOCK INSERTS, ONE KEY SYSTEM
• DOUBLE-SIDED PATTERN	

SURCHARGES

DOOR FRAME ALUTHERM OPTIMA	✓	AMSTERDAM / MONTREAL HANDHOLD 1500 mm, RECOMMENDED ELECTRIC STRIKE	✓
SIZE 100E	✓	AMSTERDAM / MONTREAL HANDHOLD 1000 mm, RECOMMENDED ELECTRIC STRIKE	✓
DOOR SHORTENING (10, 20, 30, 40 mm)	✓	AMSTERDAM / MONTREAL HANDHOLD 1500 mm WITH PUSHBUTTON, WITH DOOR LEAF ADJUSTMENT, ELECTRIC STRIKE REQUIRED	✓
TWO-COLOR DOOR	✓	AMSTERDAM / MONTREAL HANDHOLD 1000 mm WITH PUSHBUTTON, WITH DOOR LEAF ADJUSTMENT, ELECTRIC STRIKE REQUIRED	✓
CLASS 6 LOCK INSERTS, ONE KEY SYSTEM	✓	ELECTRIC STRIKE WITH DAY / NIGHT FEATURE	✓
UPPER ESCUTCHEON PROTECTION	✓	REED SWITCH	✓
KNOB-HANDLE	✓	TEDEE SET	✓

* FIXED ALUMINUM ILLUMINATORS – PAGES 88–89, FULL EQUIPMENT LIST – PAGES 94–99

GLASS



MATTE

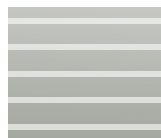

MATTE, SEE-THROUGH STRIPS



GRAPHITE



MIRA STAR (MIRROR GLASS)

DOOR COLORS

ALPINE WALNUT



FRR

MAHOGANY



FMA

BRAZILIAN WALNUT



FRB

LIGHT WALNUT



FRP

GOLD OAK



FDE

WINCHESTER



FDW

LIGHT WENGE



FEJ

WHITE



FSB

STEEL GRAY



FKZ

ANTHRACITE



FKG

DARK ANTHRACITE



FKF

BLACK



FKC



NT2 TURYN 2



NT2B TURYN 2B

FITTINGS

HANDLE-HANDLE



HANDLE-KNOB



HANDHOLD

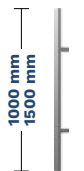

□ AMSTERDAM

○ MONTREAL

FITTING COLORS

ANODED PLATINUM



ANODED SILVER



ANODED BLACK



DOOR COLORS

ALPINE WALNUT



MAHOGANY



BRAZILIAN WALNUT



LIGHT WALNUT



GOLD OAK



WINCHESTER



LIGHT WENGE



WHITE



STEEL GRAY



ANTHRACITE



DARK ANTHRACITE



BLACK



TEMPO

BERGAMO / NICEA / BERLIN



SOJ BERGAMO 2



SJ9 NICEA 9

SIZE	80N	80	90N	90E	100E
------	-----	----	-----	-----	------

MODEL	OPTIMA 50	OPTIMA 60
SOJ BERGAMO 2	-	✓
SJ9 NICEA 9	-	✓
SBE BERLIN	-	✓

RC2 STANDARD EQUIPMENT

- GLAZED DOOR LEAF, COMPLIANT WITH THE "CLEAN AIR" PROGRAM TERMS
- 3 DOOR LEAF UPSTANDS
- OPTIMA 60 PERFOTHERM DOOR FRAME
- 2D HINGE WITH CAPS IN FITTING COLORS
- DOUBLE-SIDED PATTERN
- ALUMINUM SILL
- FITTINGS SET WITH INSERT PROTECTION
- BERGEN AND BLOK SPLIT ESCUTCHEONS
- CLASS 5 LOCK INSERTS, ONE KEY SYSTEM

SURCHARGES

DOOR FRAME ALUTHERM OPTIMA	✓	AMSTERDAM / MONTREAL HANDHOLD 1500 mm, RECOMMENDED ELECTRIC STRIKE	✓
SIZE 100E	✓	AMSTERDAM / MONTREAL HANDHOLD 1000 mm, RECOMMENDED ELECTRIC STRIKE	✓
DOOR SHORTENING SOJ (10, 20, 30, 40 mm) SJ9, SBE (10, 20, 30, 40, 60, 80, 100 mm)	✓	AMSTERDAM / MONTREAL HANDHOLD 1500 mm WITH PUSHBUTTON, WITH DOOR LEAF ADJUSTMENT, ELECTRIC STRIKE REQUIRED	✓
TWO-COLOR DOOR	✓	AMSTERDAM / MONTREAL HANDHOLD 1000 mm WITH PUSHBUTTON, WITH DOOR LEAF ADJUSTMENT, ELECTRIC STRIKE REQUIRED	✓
CLASS 6 LOCK INSERTS, ONE KEY SYSTEM	✓	ELECTRIC STRIKE WITH DAY / NIGHT FEATURE	✓
UPPER ESCUTCHEON PROTECTION	✓	REED SWITCH	✓
KNOB-HANDLE	✓	TEDEE SET	✓

* FIXED ALUMINUM ILLUMINATORS – PAGES 88–89, FULL EQUIPMENT LIST – PAGES 94–99

GLASS (BERGAMO / NICEA)



MATTE

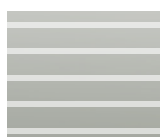

MATTE,
SEE-THROUGH
STRIPS



MIRA STAR
(MIRROR GLASS)

DOOR COLORS

ALPINE WALNUT



FRR

MAHOGANY



FMA

BRAZILIAN WALNUT



FRB

LIGHT WALNUT



FRP

GOLD OAK



FDE

WINCHESTER



FDW

LIGHT WENGE



FEJ

WHITE



FSB

STEEL GRAY



FKZ

ANTHRACITE



FKG

DARK ANTHRACITE



FKF

BLACK



FKC



SBE BERLIN

GLASS (BERLIN)



MATTE



BROWN REFLECTIVE

DOOR COLORS

ALPINE WALNUT



FRR

MAHOGANY



FMA

BRAZILIAN WALNUT



FRB

LIGHT WALNUT



FRP

GOLD OAK



FDE

WINCHESTER



FDW

LIGHT WENGE



FEJ

WHITE



FSB

STEEL GRAY



FKZ

ANTHRACITE



FKG

DARK ANTHRACITE



FKF

BLACK



FKC

FITTINGS

HANDLE-HANDLE



HANDLE-KNOB



HANDHOLD



AMSTERDAM

MONTREAL

FITTING COLORS

ANODED PLATINUM



ANODED SILVER



ANODED BLACK





ST4 UPPSALA 1
(Pressed without inserts)



ST4A UPPSALA 1A (Stainless inserts)

SIZE	80N	80	90N	90E	100E
------	-----	----	-----	-----	------

MODEL	OPTIMA 50	OPTIMA 60
ST4 UPPSALA 1	✓	✓
ST4A UPPSALA 1A	✓	✓
ST5 UPPSALA 2	✓	✓
ST5A UPPSALA 2A	✓	✓

RC2 STANDARD EQUIPMENT

- GLAZED DOOR LEAF, COMPLIANT WITH THE "CLEAN AIR" PROGRAM TERMS
- 3 DOOR LEAF UPSTANDS
- OPTIMA 50 STEEL DORFRAME, OPTIMA 60 PERFOTHERM DOOR FRAME
- 2D HINGE WITH CAPS IN FITTING COLORS
- DOUBLE-SIDED PATTERN
- ALUMINUM SILL
- FITTINGS SET WITH INSERT PROTECTION
- BERGEN AND BLOK SPLIT ESCUTCHEONS
- CLASS 5 LOCK INSERTS, ONE KEY SYSTEM

SURCHARGES

ALUTHERM OPTIMA DOOR FRAME (OPTIMA 60)	✓	AMSTERDAM / MONTREAL HANDHOLD 1500 mm, RECOMMENDED ELECTRIC STRIKE	✓
PERFOTHERM STEEL DOOR FRAME (OPTIMA 50)	✓	AMSTERDAM / MONTREAL HANDHOLD 1000 mm, RECOMMENDED ELECTRIC STRIKE	✓
SIZE 100E	✓	AMSTERDAM / MONTREAL HANDHOLD 1500 mm WITH PUSHBUTTON, WITH DOOR LEAF ADJUSTMENT, ELECTRIC STRIKE REQUIRED	✓
RC3 PACKAGE	✓	AMSTERDAM / MONTREAL HANDHOLD 1000 mm WITH PUSHBUTTON, WITH DOOR LEAF ADJUSTMENT, ELECTRIC STRIKE REQUIRED	✓
DOOR SHORTENING (10, 20, 30, 40 mm)	✓	ELECTRIC STRIKE WITH DAY / NIGHT FEATURE	✓
TWO-COLOR DOOR	✓	REED SWITCH	✓
CLASS 6 LOCK INSERTS, ONE KEY SYSTEM	✓	TEDEE SET	✓
UPPER ESCUTCHEON PROTECTION	✓		
KNOB-HANDLE	✓		

* FIXED ALUMINUM ILLUMINATORS – PAGES 88–89, FULL EQUIPMENT LIST – PAGES 94–99

DOOR COLORS

ALPINE WALNUT



FRR

MAHOGANY



FMA

BRAZILIAN WALNUT



FRB

LIGHT WALNUT



FRP

GOLD OAK



FDE

WINCHESTER



FDW

LIGHT WENGE



FEJ

WHITE



FSB

STEEL GRAY



FKZ

ANTHRACITE



FKG

DARK ANTHRACITE



FKF

BLACK



FKC



ST5 UPPSALA 2
(Pressed without inserts)



ST5A UPPSALA 2A (Stainless inserts)

FITTINGS

HANDLE-HANDLE



HANDLE-KNOB



HANDHOLD

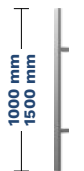

- AMSTERDAM
- MONTREAL

FITTING COLORS

ANODED PLATINUM



ANODED SILVER



ANODED BLACK



DOOR COLORS

ALPINE WALNUT



MAHOGANY



BRAZILIAN WALNUT



LIGHT WALNUT



GOLD OAK



WINCHESTER



LIGHT WENGE



WHITE



STEEL GRAY



ANTHRACITE



DARK ANTHRACITE



BLACK





TML TOKIO 1
(Pressed without inserts)



TMLA TOKIO 1A (Stainless inserts)

SIZE	80N	80	90N	90E	100E
------	-----	----	-----	-----	------

MODEL	OPTIMA 50	OPTIMA 60
TML TOKIO 1	✓	✓
TMLA TOKIO 1A	✓	✓
TMm TOKIO 2	✓	✓
TMmA TOKIO 2A	✓	✓

RC2 STANDARD EQUIPMENT

- GLAZED DOOR LEAF, COMPLIANT WITH THE "CLEAN AIR" PROGRAM TERMS
- 3 DOOR LEAF UPSTANDS
- OPTIMA 50 STEEL DORFRAME, OPTIMA 60 PERFOTHERM DOOR FRAME
- 2D HINGE WITH CAPS IN FITTING COLORS
- DOUBLE-SIDED PATTERN
- ALUMINUM SILL
- FITTINGS SET WITH INSERT PROTECTION
- BERGEN AND BLOK SPLIT ESCUTCHEONS
- CLASS 5 LOCK INSERTS, ONE KEY SYSTEM

SURCHARGES

ALUTHERM OPTIMA DOOR FRAME (OPTIMA 60)	✓	AMSTERDAM / MONTREAL HANDHOLD 1500 mm, RECOMMENDED ELECTRIC STRIKE	✓
PERFOTHERM STEEL DOOR FRAME (OPTIMA 50)	✓	AMSTERDAM / MONTREAL HANDHOLD 1000 mm, RECOMMENDED ELECTRIC STRIKE	✓
SIZE 100E	✓	AMSTERDAM / MONTREAL HANDHOLD 1500 mm WITH PUSHBUTTON, WITH DOOR LEAF ADJUSTMENT, ELECTRIC STRIKE REQUIRED	✓
RC3 PACKAGE	✓	AMSTERDAM / MONTREAL HANDHOLD 1000 mm WITH PUSHBUTTON, WITH DOOR LEAF ADJUSTMENT, ELECTRIC STRIKE REQUIRED	✓
DOOR SHORTENING (10, 20, 30, 40 mm)	✓	ELECTRIC STRIKE WITH DAY / NIGHT FEATURE	✓
TWO-COLOR DOOR	✓	REED SWITCH	✓
CLASS 6 LOCK INSERTS, ONE KEY SYSTEM	✓	TEDEE SET	✓
UPPER ESCUTCHEON PROTECTION	✓		
KNOB-HANDLE	✓		

* FIXED ALUMINUM ILLUMINATORS – PAGES 88-89, FULL EQUIPMENT LIST – PAGES 94-99

DOOR COLORS

ALPINE WALNUT



FRR

MAHOGANY



FMA

BRAZILIAN WALNUT



FRB

LIGHT WALNUT



FRP

GOLD OAK



FDE

WINCHESTER



FDW

LIGHT WENGE



FEJ

WHITE



FSB

STEEL GRAY



FKZ

ANTHRACITE



FKG

DARK ANTHRACITE



FKF

BLACK



FKC



TMm TOKIO 2
(Pressed without inserts)



TMmA TOKIO 2A (Stainless inserts)

FITTINGS

HANDLE-HANDLE



HANDLE-KNOB



HANDHOLD

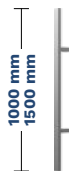

- AMSTERDAM
- MONTREAL

FITTING COLORS

ANODED PLATINUM



ANODED SILVER



ANODED BLACK



DOOR COLORS

ALPINE WALNUT



MAHOGANY



BRAZILIAN WALNUT



LIGHT WALNUT



GOLD OAK



WINCHESTER



LIGHT WENGE



WHITE



STEEL GRAY



ANTHRACITE



DARK ANTHRACITE



BLACK



TEMPO RYGA / LUND / ASPEN



ST8 RYGA



ST9 LUND

SIZE	80N	80	90N	90E	100E
------	-----	----	-----	-----	------

MODEL	OPTIMA 50	OPTIMA 60
ST8 RYGA	✓	✓
ST9 LUND	✓	✓
WBA ASPEN 1	✓	✓
TN7 ASPEN 2	✓	✓
TN7B ASPEN 2B	✓	✓

RC2 STANDARD EQUIPMENT

- DOOR LEAF COMPLIANT WITH THE "CLEAN AIR" PROGRAM TERMS
- 3 DOOR LEAF UPSTANDS
- OPTIMA 50 STEEL DOOR FRAME, OPTIMA 60 PERFOOTHERM DOOR FRAME
- 2D HINGE WITH CAPS IN FITTING COLORS
- DOUBLE-SIDED PATTERN
- ALUMINUM SILL
- FITTINGS SET WITH INSERT PROTECTION
- BERGEN AND BLOK SPLIT ESCUTCHEONS
- CLASS 5 LOCK INSERTS, ONE KEY SYSTEM

SURCHARGES

ALUTHERM OPTIMA DOOR FRAME (OPTIMA 60)	✓	AMSTERDAM / MONTREAL HANDHOLD 1500 mm, RECOMMENDED ELECTRIC STRIKE	✓
PERFOOTHERM STEEL DOOR FRAME (OPTIMA 50)	✓	AMSTERDAM / MONTREAL HANDHOLD 1000 mm, RECOMMENDED ELECTRIC STRIKE	✓
SIZE 100E	✓	AMSTERDAM / MONTREAL HANDHOLD 1500 mm WITH PUSHBUTTON, WITH DOOR LEAF ADJUSTMENT, ELECTRIC STRIKE REQUIRED	✓
RC3 PACKAGE	✓	AMSTERDAM / MONTREAL HANDHOLD 1000 mm WITH PUSHBUTTON, WITH DOOR LEAF ADJUSTMENT, ELECTRIC STRIKE REQUIRED	✓
DOOR SHORTENING WBA, TN7, TN7B (10, 20, 30, 40, 60, 80, 100 mm)	✓	ELECTRIC STRIKE WITH DAY / NIGHT FEATURE	✓
TWO-COLOR DOOR	✓	REED SWITCH	✓
CLASS 6 LOCK INSERTS, ONE KEY SYSTEM	✓	TEDEE SET	✓
UPPER ESCUTCHEON PROTECTION	✓		
KNOB-HANDLE	✓		

* FIXED ALUMINUM ILLUMINATORS – PAGES 88–89, FULL EQUIPMENT LIST – PAGES 94–99

DOOR COLORS

ALPINE WALNUT



FRR

MAHOGANY



FMA

BRAZILIAN WALNUT



FRB

LIGHT WALNUT



FRP

GOLD OAK



FDE

WINCHESTER



FDW

LIGHT WENGE



FEJ

WHITE



FSB

STEEL GRAY



FKZ

ANTHRACITE



FKG

DARK ANTHRACITE



FKF

BLACK



FKC



WBA ASPEN 1



TN7 ASPEN 2



TN7B ASPEN 2B

FITTINGS

HANDLE-HANDLE



HANDLE-KNOB

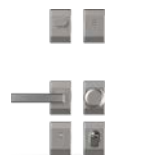

HANDHOLD

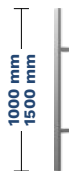

□ AMSTERDAM

○ MONTREAL

FITTING COLORS

ANODED PLATINUM



ANODED SILVER



ANODED BLACK



DOOR COLORS

ALPINE WALNUT



MAHOGANY



BRAZILIAN WALNUT



LIGHT WALNUT



GOLD OAK



WINCHESTER



LIGHT WENGE



WHITE



STEEL GRAY



ANTHRACITE



DARK ANTHRACITE



BLACK





SR3 TROMSO



SR4 TROMSO 1

SIZE	80N	80	90N	90E	100E
------	-----	----	-----	-----	------

MODEL	OPTIMA 50	OPTIMA 60
SR3 TROMSO	✓	✓
SR4 TROMSO 1	✓	✓
SR5 TROMSO 2	✓	✓

RC2 STANDARD EQUIPMENT

- DOOR LEAF COMPLIANT WITH THE "CLEAN AIR" PROGRAM TERMS
- 3 DOOR LEAF UPSTANDS
- OPTIMA 50 STEEL DOOR FRAME, OPTIMA 60 PERFOOTHERM DOOR FRAME
- 2D HINGE WITH CAPS IN FITTING COLORS
- DOUBLE-SIDED PATTERN
- ALUMINUM SILL
- FITTINGS SET WITH INSERT PROTECTION
- BERGEN AND BLOK SPLIT ESCUTCHEONS
- CLASS 5 LOCK INSERTS, ONE KEY SYSTEM

SURCHARGES

ALUTHERM OPTIMA DOOR FRAME (OPTIMA 60)	✓	AMSTERDAM / MONTREAL HANDHOLD 1500 mm, RECOMMENDED ELECTRIC STRIKE	✓
PERFOOTHERM STEEL DOOR FRAME (OPTIMA 50)	✓	AMSTERDAM / MONTREAL HANDHOLD 1000 mm, RECOMMENDED ELECTRIC STRIKE	✓
SIZE 100E	✓	AMSTERDAM / MONTREAL HANDHOLD 1500 mm WITH PUSHBUTTON, WITH DOOR LEAF ADJUSTMENT, ELECTRIC STRIKE REQUIRED	✓
RC3 PACKAGE	✓	AMSTERDAM / MONTREAL HANDHOLD 1000 mm WITH PUSHBUTTON, WITH DOOR LEAF ADJUSTMENT, ELECTRIC STRIKE REQUIRED	✓
DOOR SHORTENING SR4 (10, 20, 30, 40 mm)	✓	ELECTRIC STRIKE WITH DAY / NIGHT FEATURE	✓
TWO-COLOR DOOR	✓	REED SWITCH	✓
CLASS 6 LOCK INSERTS, ONE KEY SYSTEM	✓	TEDEE SET	✓
UPPER ESCUTCHEON PROTECTION	✓		
KNOB-HANDLE	✓		

* FIXED ALUMINUM ILLUMINATORS – PAGES 88–89, FULL EQUIPMENT LIST – PAGES 94–99

DOOR COLORS

ALPINE WALNUT



FRR

MAHOGANY



FMA

BRAZILIAN WALNUT



FRB

LIGHT WALNUT



FRP

GOLD OAK



FDE

WINCHESTER



FDW

LIGHT WENGE



FEJ

WHITE



FSB

STEEL GRAY



FKZ

ANTHRACITE



FKG

DARK ANTHRACITE



FKF

BLACK



FKC



SR5 TROMSO 2

FITTINGS

HANDLE-HANDLE



HANDLE-KNOB



HANDHOLD

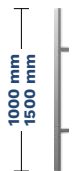

- AMSTERDAM
- MONTREAL

FITTING COLORS

ANODED PLATINUM



ANODED SILVER



ANODED BLACK



DOOR COLORS

ALPINE WALNUT



MAHOGANY



BRAZILIAN WALNUT



LIGHT WALNUT



GOLD OAK



WINCHESTER



LIGHT WENGE



WHITE



STEEL GRAY



ANTHRACITE



DARK ANTHRACITE



BLACK



CLASSIC MODENA / RAVENA



W76 MODENA



W77 MODENA 2

SIZE	80	90N	90E
------	----	-----	-----

MODEL	OPTIMA 50	OPTIMA 60
W76 MODENA	-	✓
W77 MODENA 2	-	✓
W78 MODENA 3	-	✓
WDR RAVENA	✓	✓

RC2 STANDARD EQUIPMENT

- | | |
|--|--|
| • GLAZED DOOR LEAF, COMPLIANT WITH THE "CLEAN AIR" PROGRAM TERMS | • ALUMINUM SILL |
| • 3 DOOR LEAF UPSTANDS | • FITTINGS SET WITH INSERT PROTECTION |
| • OPTIMA 50 STEEL DOOR FRAME, OPTIMA 60 PERFOTHERM DOOR FRAME | • BERGEN AND BLOK SPLIT ESCUTCHEONS |
| • 2D HINGE WITH CAPS IN FITTING COLORS | • CLASS 5 LOCK INSERTS, ONE KEY SYSTEM |
| • DOUBLE-SIDED PATTERN | • DEEP STAMPING |

SURCHARGES

ALUTHERM OPTIMA DOOR FRAME (OPTIMA 60)	✓	ELECTRIC STRIKE WITH DAY / NIGHT FEATURE	✓
PERFOTHERM STEEL DOOR FRAME (OPTIMA 50)	✓	REED SWITCH	✓
RC3 PACKAGE (OPTIMA 60 DESIGN WDR)	✓	TEDEE SET	✓
DOOR SHORTENING (10, 20, 30, 40, 60, 80, 100 mm)	✓		
TWO-COLOR DOOR	✓		
CLASS 6 LOCK INSERTS, ONE KEY SYSTEM	✓		
UPPER ESCUTCHEON PROTECTION	✓		
KNOB-HANDLE	✓		

* FIXED ALUMINUM ILLUMINATORS – PAGES 88–89, FULL EQUIPMENT LIST – PAGES 94–99

GLASS



MATTE



BROWN REFLECTIVE



MIRA STAR (MIRROR GLASS)

DOOR COLORS

ALPINE WALNUT



FRR

MAHOGANY



FMA

BRAZILIAN WALNUT



FRB

LIGHT WALNUT



FRP

GOLD OAK



FDE

WINCHESTER



FDW

WHITE



FSB

STEEL GRAY



FKZ

ANTHRACITE



FKG

DARK ANTHRACITE



FKF



W78 MODENA 3



WDR RAVENA

FITTINGS

HANDLE-HANDLE



HANDLE-KNOB

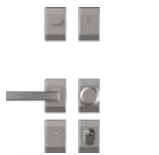

FITTING COLORS

ANODED PLATINUM



ANODED SILVER



ANODED BLACK



DOOR COLORS

ALPINE WALNUT



MAHOGANY



BRAZILIAN WALNUT



LIGHT WALNUT



GOLD OAK



WINCHESTER



WHITE



STEEL GRAY



ANTHRACITE



DARK ANTHRACITE



CLASSIC NICEA / OLYMPIA



WJ1 NICEA 5

SIZE	80	90N	90E
------	----	-----	-----

MODEL	OPTIMA 50	OPTIMA 60
WJ1 NICEA 5	-	✓
W23 OLYMPIA	-	✓

RC2 STANDARD EQUIPMENT

- GLAZED DOOR LEAF, COMPLIANT WITH THE "CLEAN AIR" PROGRAM TERMS
- 3 DOOR LEAF UPSTANDS
- OPTIMA 60 PERFOTHERM DOOR FRAME
- 2D HINGE WITH CAPS IN FITTING COLORS
- DOUBLE-SIDED PATTERN
- ALUMINUM SILL
- FITTINGS SET WITH INSERT PROTECTION
- BERGEN AND BLOK SPLIT ESCUTCHEONS
- CLASS 5 LOCK INSERTS, ONE KEY SYSTEM
- DEEP STAMPING

SURCHARGES

ALUTHERM OPTIMA DOOR FRAME (OPTIMA 60)	✓	ELECTRIC STRIKE WITH DAY / NIGHT FEATURE	✓
PERFOTHERM STEEL DOOR FRAME (OPTIMA 50)	✓	REED SWITCH	✓
SIZE 100E (DESIGN W23)	✓	TEDEE SET	✓
DOOR SHORTENING (10, 20, 30, 40, 60, 80, 100 mm)	✓		
TWO-COLOR DOOR	✓		
CLASS 6 LOCK INSERTS, ONE KEY SYSTEM	✓		
UPPER ESCUTCHEON PROTECTION	✓		
KNOB-HANDLE	✓		

* FIXED ALUMINUM ILLUMINATORS – PAGES 88–89, FULL EQUIPMENT LIST – PAGES 94–99

GLASS



MATTE



GRAPHITE



MIRA STAR (MIRROR GLASS)

DOOR COLORS

ALPINE WALNUT



FRR

MAHOGANY



FMA

BRAZILIAN WALNUT



FRB

LIGHT WALNUT



FRP

GOLD OAK



FDE

WINCHESTER



FDW

WHITE



FSB

STEEL GRAY



FKZ

ANTHRACITE



FKG

DARK ANTHRACITE



FKF



W23 OLYMPIA

FITTINGS

HANDLE-HANDLE



HANDLE-KNOB



FITTING COLORS

ANODED PLATINUM



ANODED SILVER



ANODED BLACK



DOOR COLORS

ALPINE WALNUT



MAHOGANY



BRAZILIAN WALNUT



LIGHT WALNUT



GOLD OAK



WINCHESTER



WHITE



STEEL GRAY



ANTHRACITE



DARK ANTHRACITE





W91 WERONA



W94 WERONA 1

SIZE	80	90N	90E
------	----	-----	-----

MODEL	OPTIMA 50	OPTIMA 60
W91 WERONA	✓	✓
W94 WERONA 1	-	✓
W93 WERONA 3	-	✓
W6A WERONA 4	-	✓
WQA WERONA 5	-	✓

RC2 STANDARD EQUIPMENT

- GLAZED DOOR LEAF, COMPLIANT WITH THE "CLEAN AIR" PROGRAM TERMS
- 3 DOOR LEAF UPSTANDS
- OPTIMA 50 STEEL DOOR FRAME, OPTIMA 60 PERFOOTHERM DOOR FRAME
- 2D HINGE WITH CAPS IN FITTING COLORS
- DOUBLE-SIDED PATTERN
- ALUMINUM SILL
- FITTINGS SET WITH INSERT PROTECTION
- BERGEN AND BLOK SPLIT ESCUTCHEONS
- CLASS 5 LOCK INSERTS, ONE KEY SYSTEM
- DEEP STAMPING

SURCHARGES

ALUTHERM OPTIMA DOOR FRAME (OPTIMA 60)	✓	ELECTRIC STRIKE WITH DAY / NIGHT FEATURE	✓
PERFOOTHERM STEEL DOOR FRAME (OPTIMA 50)	✓	REED SWITCH	✓
RC3 PACKAGE (OPTIMA 60 DESIGN W91)	✓	CLASS 6 LOCK INSERTS, ONE KEY SYSTEM	✓
DOOR SHORTENING (10, 20, 30, 40, 60, 80, 100 mm)	✓	UPPER ESCUTCHEON PROTECTION	✓
TWO-COLOR DOOR	✓	TEDEE SET	✓
KNOB-HANDLE	✓		

* FIXED ALUMINUM ILLUMINATORS – PAGES 88–89, FULL EQUIPMENT LIST – PAGES 94–99

GLASS



MATTE



BROWN REFLECTIVE



MIRA STAR (MIRROR GLASS)

DOOR COLORS

ALPINE WALNUT



FRR

MAHOGANY



FMA

BRAZILIAN WALNUT



FRB

LIGHT WALNUT



FRP

GOLD OAK



FDE

WINCHESTER



FDW

WHITE



FSB

STEEL GRAY



FKZ

ANTHRACITE



FKG

DARK ANTHRACITE



FKF



W93 WERONA 3



W6A WERONA 4



WQA WERONA 5

FITTINGS

HANDLE-HANDLE



HANDLE-KNOB

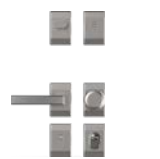

FITTING COLORS

ANODED PLATINUM



ANODED SILVER



ANODED BLACK



DOOR COLORS

ALPINE WALNUT



FRR

MAHOGANY



FMA

BRAZILIAN WALNUT



FRB

LIGHT WALNUT



FRP

GOLD OAK



FDE

WINCHESTER



FDW

WHITE



FSB

STEEL GRAY



FKZ

ANTHRACITE



FKG

DARK ANTHRACITE



FKF

CLASSIC

LIZBONA / WENECJA / LONDYN



W24 LIZBONA



W9N WENECJA

SIZE	80	90N	90E
------	----	-----	-----

MODEL	OPTIMA 50	OPTIMA 60
W24 LIZBONA	✓	✓
W9N WENECJA	✓	✓
W13 LONDYN	✓	✓
W5L LONDYN 1	-	✓

RC2 STANDARD EQUIPMENT

- GLAZED DOOR LEAF, COMPLIANT WITH THE "CLEAN AIR" PROGRAM TERMS
- 3 DOOR LEAF UPSTANDS
- OPTIMA 50 STEEL DOOR FRAME, OPTIMA 60 PERFOTHERM DOOR FRAME
- 2D HINGE WITH CAPS IN FITTING COLORS
- DOUBLE-SIDED PATTERN
- ALUMINUM SILL
- FITTINGS SET WITH INSERT PROTECTION
- BERGEN AND BLOK SPLIT ESCUTCHEONS
- CLASS 5 LOCK INSERTS, ONE KEY SYSTEM
- DEEP STAMPING

SURCHARGES

ALUTHERM OPTIMA DOOR FRAME (OPTIMA 60)	✓	ELECTRIC STRIKE WITH DAY / NIGHT FEATURE	✓
PERFOTHERM STEEL DOOR FRAME (OPTIMA 50)	✓	REED SWITCH	✓
RC3 PACKAGE (OPTIMA 60 DESIGN W24, W9N, W13)	✓	CLASS 6 LOCK INSERTS, ONE KEY SYSTEM	✓
DOOR SHORTENING (10, 20, 30, 40, 60, 80, 100 mm)	✓	UPPER ESCUTCHEON PROTECTION	✓
TWO-COLOR DOOR	✓	TEDEE SET	✓
KNOB-HANDLE	✓		

* FIXED ALUMINUM ILLUMINATORS – PAGES 88–89, FULL EQUIPMENT LIST – PAGES 94–99

GLASS



MATTE



BROWN REFLECTIVE



MIRA STAR (MIRROR GLASS)

DOOR COLORS

ALPINE WALNUT



FRR

MAHOGANY



FMA

BRAZILIAN WALNUT



FRB

LIGHT WALNUT



FRP

GOLD OAK



FDE

WINCHESTER



FDW

WHITE



FSB

STEEL GRAY



FKZ

ANTHRACITE



FKG

DARK ANTHRACITE



FKF

GERDA CLASSIC

LIZBONA / WENECJA / LONDYN



W13 LONDYN



W5L LONDYN 1

FITTINGS

HANDLE-HANDLE



HANDLE-KNOB



FITTING COLORS

ANODED PLATINUM



ANODED SILVER



ANODED BLACK



DOOR COLORS

ALPINE WALNUT



MAHOGANY



BRAZILIAN WALNUT



LIGHT WALNUT



GOLD OAK



WINCHESTER



WHITE



STEEL GRAY



ANTHRACITE



DARK ANTHRACITE



FRR

FMA

FRB

FRP

FDE

FDW

FSB

FKZ

FKG

FKF

CLASSIC BARCELONA / GENEWA



W54 BARCELONA



W53 BARCELONA 1

SIZE

80	90N	90E
----	-----	-----

MODEL

OPTIMA 50

OPTIMA 60

W54 BARCELONA

✓

✓

W53 BARCELONA 1

-

✓

G76 GENEWA 1

-

✓

G75 GENEWA 2

-

✓

D75 GENEWA 3

✓

✓

RC2 STANDARD EQUIPMENT

- GLAZED DOOR LEAF, COMPLIANT WITH THE "CLEAN AIR" PROGRAM TERMS
- 3 DOOR LEAF UPSTANDS
- OPTIMA 50 STEEL DOOR FRAME, OPTIMA 60 PERFOOTHERM DOOR FRAME
- 2D HINGE WITH CAPS IN FITTING COLORS
- DOUBLE-SIDED PATTERN
- ALUMINUM SILL
- FITTINGS SET WITH INSERT PROTECTION
- BERGEN AND BLOK SPLIT ESCUTCHEONS
- CLASS 5 LOCK INSERTS, ONE KEY SYSTEM
- DEEP STAMPING (BARCELONA)

SURCHARGES

ALUTHERM OPTIMA DOOR FRAME (OPTIMA 60)	✓	ELECTRIC STRIKE WITH DAY / NIGHT FEATURE	✓
PERFOOTHERM STEEL DOOR FRAME (OPTIMA 50)	✓	REED SWITCH	✓
RC3 PACKAGE (OPTIMA 60 DESIGN W54, D75)	✓	CLASS 6 LOCK INSERTS, ONE KEY SYSTEM	✓
DOOR SHORTENING (10, 20, 30, 40, 60, 80, 100 mm)	✓	UPPER ESCUTCHEON PROTECTION	✓
TWO-COLOR DOOR	✓	TEDEE SET	✓
KNOB-HANDLE	✓		

* FIXED ALUMINUM ILLUMINATORS – PAGES 88–89, FULL EQUIPMENT LIST – PAGES 94–99

GLASS



MATTE



BROWN REFLECTIVE



MIRA STAR (MIRROR GLASS)

DOOR COLORS

ALPINE WALNUT

FRR

MAHOGANY

FMA

BRAZILIAN WALNUT

FRB

LIGHT WALNUT

FRP

GOLD OAK

FDE

WINCHESTER

FDW

WHITE

FSB

STEEL GRAY

FKZ

ANTHRACITE

FKG

DARK ANTHRACITE

FKF



G76 GENEWA 1



G75 GENEWA 2



D75 GENEWA 3

FITTINGS

HANDLE-HANDLE



HANDLE-KNOB

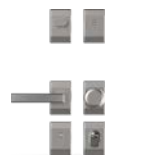

FITTING COLORS

ANODED PLATINUM



ANODED SILVER



ANODED BLACK



DOOR COLORS

ALPINE WALNUT



MAHOGANY



BRAZILIAN WALNUT



LIGHT WALNUT



GOLD OAK



WINCHESTER



WHITE



STEEL GRAY



ANTHRACITE



DARK ANTHRACITE



OPTIMA 60 DUO DOOR



OPTIMA DUO 60 have been designed for people looking for a custom-size door. A passive door leaf enables a broader passage. Passive door leaves are available both with and without glass, serving as illuminators at the same time.

PARAMETERS

- ✓ SINGLE- AND MULTI-FAMILY BUILDING ENTRANCE DOOR
- ✓ STEEL DOOR LEAVES 60 MM THICK, FILLED WITH EXPANDED GRAPHITE POLYSTYRENE
- ✓ AVAILABLE WITH PERFOTHERM DOOR FRAME AND ALUMINUM SILL; OPTIONALLY, WITH A SURCHARGE, ALUTHERM OPTIMA ALUMINUM DOOR FRAME
- ✓ PASSIVE DOOR LEAVES IN SOLID AND GLAZED DESIGN, IN SIZES 30, 40, 50
- ✓ DOOR AVAILABLE IN 12 COLORS

DOOR FRAME EXTERNAL DIMENSIONS AND MOUNTING HOLES – SEE PAGES 104–105

PASSIVE DOOR DESIGNS

The passive door leaf price includes attachment price, as well as sill and door frame surcharge.

NAME	SIZE
P00	30 40 50
PD4	40
GH1	40 50
GC2	40 50
GN5	30 40 50
GPD	30 40 50
DN3 / DN3B	30 40 50
DN6 / DN6B	30 40 50
DT8 / DT8B	30 40 50
DW9 / DW9B	30 40 50
DW8 / DW8B	30 40 50
DPE / DPEB	30 40 50
PD5	30 40 50
PD5A	30 40 50
PD5B	30 40 50
NMB	30 40 50
NMBA	30 40 50
NMBB	30 40 50
NMA	30 40 50
NMAA	30 40 50
NMAB	30 40 50

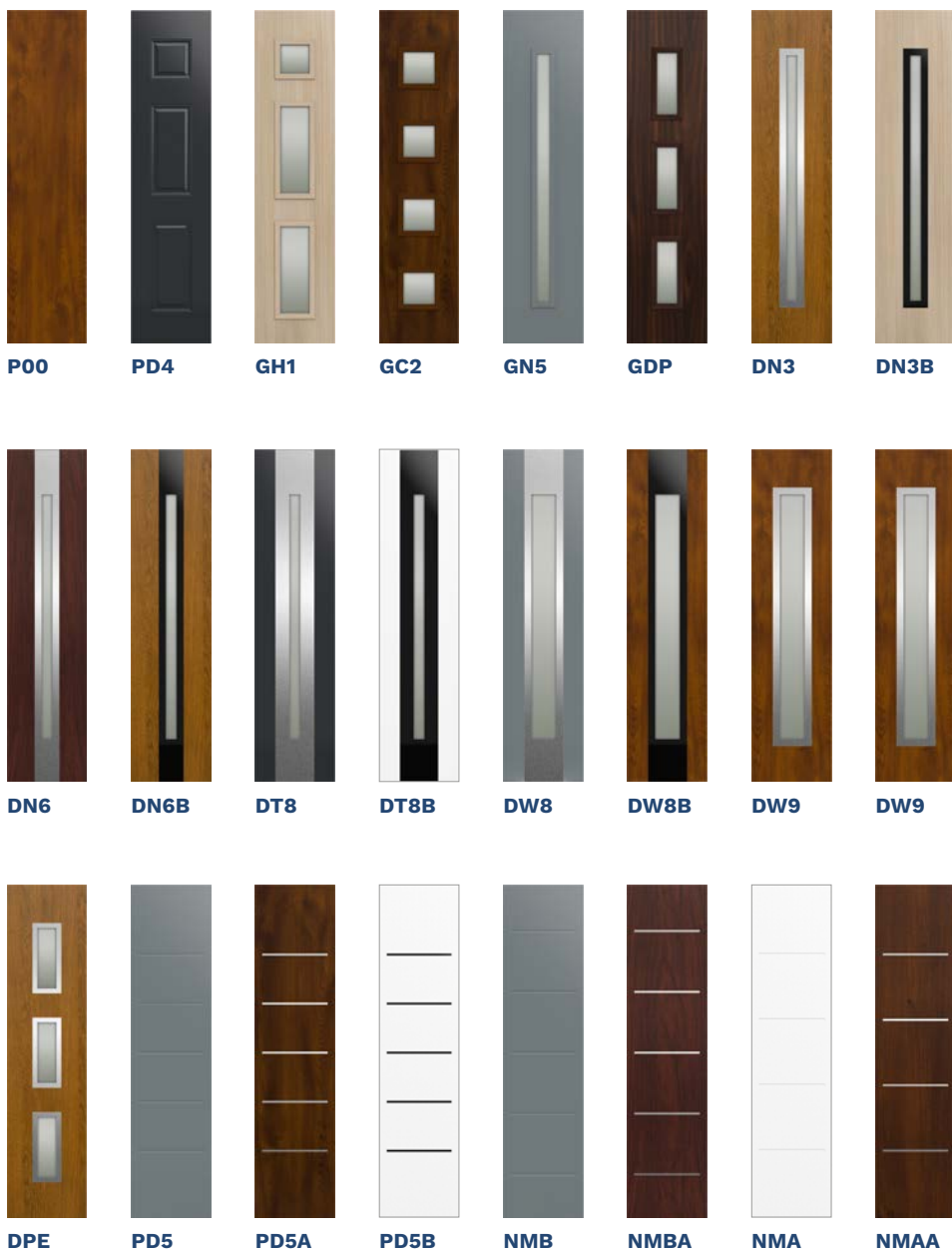

GERDA[®] OPTIMA 60 DUO DOOR



SOJ BERGAMO2 + NMBA



NS5 HANOVER 5 + DW9



ST8 RYGA + P00



TMMA TOKIO 2A + P00



NS9 MILANO 12 + DW8



SNUA MILANO 4A + PD5A



NT2B TURYN 2B + DT8



ST4A UPPSALA 1A + NMAA



NS6 HANOVER 6 + DW8

ALUMINUM ILLUMINATORS

GERDA®



GL SET



G SET



GP SET



L SET

ALUMINUM ILLUMINATORS
THERMO PRIME 75 DOORS

ALUTHERM PRIME DOOR FRAME

SIZE	Height Hz	Width B
80	standard 2087 mm custom: 2150 mm 2200 mm 2250 mm 2300 mm 2350 mm 2400 mm	918 mm
90N		988 mm
90E		1031 mm
100E		1131 mm

SIDE ILLUMINATORS

TOTAL HEIGHT	ILLUMINATOR / GLASS TYPE	WIDTH	
		300 - 550 mm	600 - 900 mm
2087 mm	ILLUMINATORS WITH SAFETY GLASS	✓	✓
	ANTI-BURGLARY RC2 ILLUMINATORS WITH P4 GLASS	✓	✓
2400 mm	ILLUMINATORS WITH SAFETY GLASS	✓	✓
	ANTI-BURGLARY RC2 ILLUMINATORS WITH P4 GLASS	✓	✓

* SIDE ILLUMINATORS STANDARD WIDTH IN 50 mm INCREMENTS. FOR 10 mm INCREMENTS - 25% SURCHARGE

TOP ILLUMINATORS

ILLUMINATOR HEIGHT	ILLUMINATOR / GLASS TYPE	WIDTH				
		918 - 1150 mm	up to 1550 mm	up to 1950 mm	up to 2350 mm	up to 2950 mm
300 - 500 mm	ILLUMINATORS WITH SAFETY GLASS	✓	✓	✓	✓	✓
300 - 500 mm	ANTI-BURGLARY RC2 ILLUMINATORS WITH P4 GLASS	✓	✓	✓	✓	✓

* TOP ILLUMINATORS STANDARD WIDTH IN 50 mm INCREMENTS. FOR 10 mm INCREMENTS - 25% SURCHARGE



P SET



LP SET



LGP SET

ALUMINUM ILLUMINATORS FOR THERMO PREMIUM 75, THERMO PREMIUM 60 AND OPTIMA 60 DOORS

ALUTHERM PREMIUM DOOR FRAME, OPTIMA

SIZE	Height Hz	Width B
80N	2087 mm	888 mm
80		918 mm
90N		988 mm
90E		1031 mm
100E		1131 mm

SIDE ILLUMINATORS

TOTAL HEIGHT	ILLUMINATOR / GLASS TYPE	WIDTH	
		250 - 550 mm	600 - 900 mm
2087 mm	ILLUMINATORS WITH SAFETY GLASS	✓	✓
	ANTI-BURGLARY RC2 ILLUMINATORS WITH P4 GLASS	✓	✓

* SIDE ILLUMINATORS STANDARD WIDTH IN 50 mm INCREMENTS. FOR 10 mm INCREMENTS - 25% SURCHARGE

TOP ILLUMINATORS

ILLUMINATOR HEIGHT	ILLUMINATOR / GLASS TYPE	WIDTH				
		888 - 1150 mm	up to 1550 mm	up to 1950 mm	up to 2350 mm	up to 2950 mm
250 - 500 mm	ILLUMINATORS WITH SAFETY GLASS	✓	✓	✓	✓	✓
250 - 500 mm	ANTI-BURGLARY RC2 ILLUMINATORS WITH P4 GLASS	✓	✓	✓	✓	✓

* TOP ILLUMINATORS STANDARD WIDTH IN 50 mm INCREMENTS. FOR 10 mm INCREMENTS - 25% SURCHARGE.

COLORS

GERDA®

CHOOSE A COLOR FOR YOUR DOOR

ALPINE WALNUT



MAHOGANY



BRAZILIAN WALNUT



LIGHT WENGE



WHITE

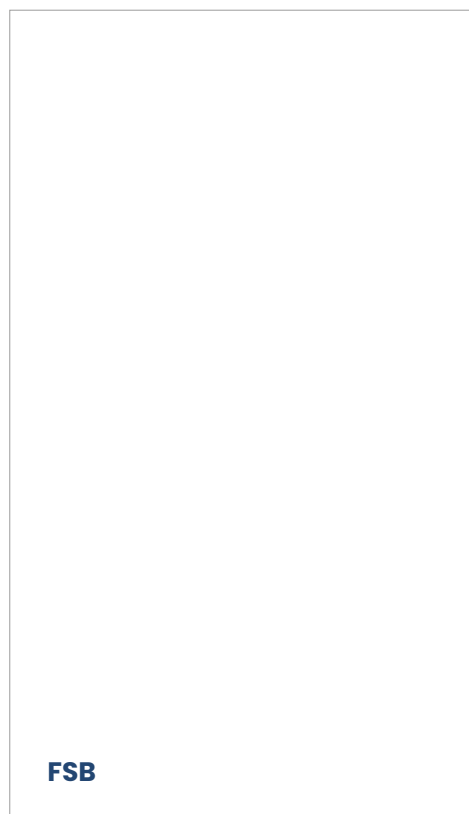

STEEL GRAY



CHOOSE A COLOR FOR YOUR DOOR

LIGHT WALNUT



GOLD OAK



WINCHESTER



ANTHRACITE

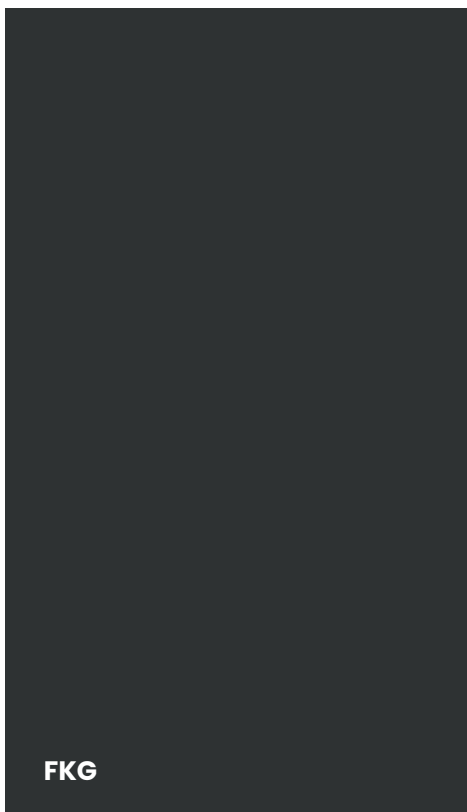

DARK ANTHRACITE

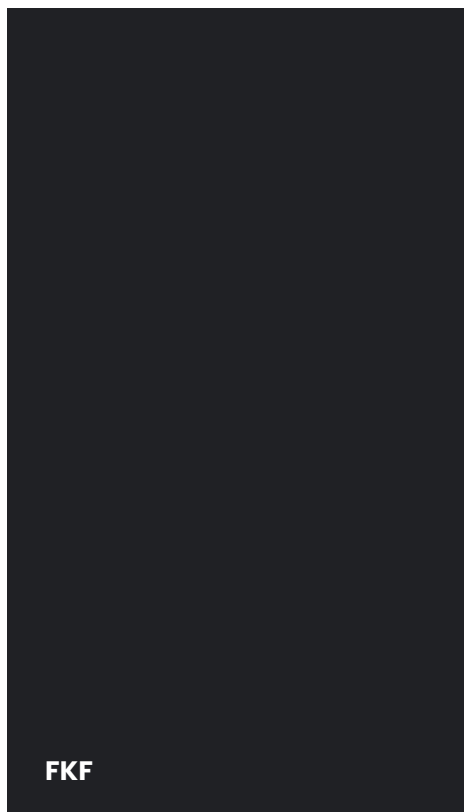

BLACK

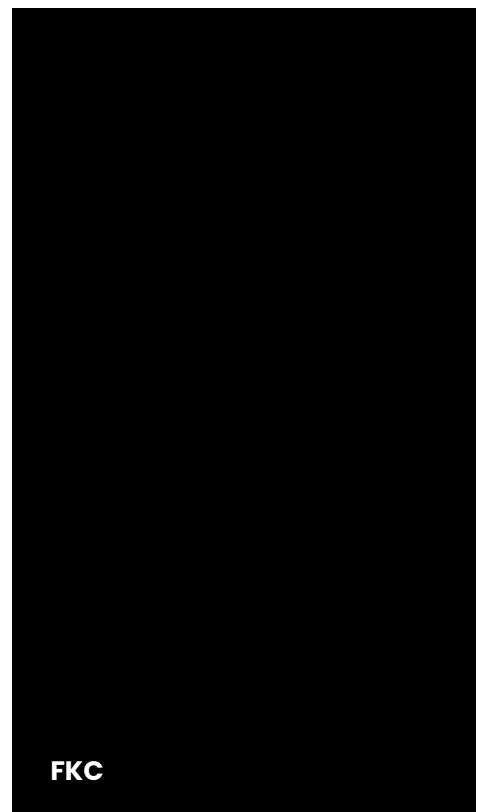

ACCESSORIES SET

GERDA®

THERMO PRIME / THERMO PREMIUM (CONFIGURATION EXAMPLE)

**TW300 BERGEN
(ALEX HANDLES)
THERMO PRIME**



**RING ESCUTCHEON
(ALEX HANDLE ON
SINGLE-SIDED), HANDHOLD**

AMSTERDAM MONTREAL



**TD200 BERGEN
(BETA HANDLES)**



**TD200 BERGEN
(ALEX KNOB-HANDLE)**



ESCUTCHEON COLORS

ANODED PLATINUM



ANODED SILVER



ANODED BLACK



THERMO PRIME/PREMIUM STANDARD ACCESSORIES SET



THERMO PRIME CLASS 5 INSERT / THERMO PREMIUM CLASS 5 INSERTS IN ONE KEY SYSTEM

5 KEYS + INSTALLATION

MAIN LOCK ESCUTCHEON WITH PROTECTION

ADDITIONAL LOCK ESCUTCHEON WITHOUT PROTECTION THERMO PREMIUM

HINGE CAPS IN ESCUTCHEON COLOR

SURCHARGES

ADDITIONAL LOCK ESCUTCHEON WITH PROTECTION



KNOB-HANDLE SET



CLASS 6 THERMO PRIME INSERT



CLASS 6 LOCK INSERTS, ONE KEY SYSTEM, THERMO PREMIUM



MAIN LOCK CLASS 5/ADDITIONAL LOCK CLASS 2 INSERT, THERMO PREMIUM



AMSTERDAM / MONTREAL HANDHOLD 1500 mm, RECOMMENDED ELECTRIC STRIKE



AMSTERDAM / MONTREAL HANDHOLD 1000 mm, RECOMMENDED ELECTRIC STRIKE



AMSTERDAM / MONTREAL HANDHOLD 1500 mm WITH PUSHBUTTON, WITH DOOR LEAF ADJUSTMENT, ELECTRIC STRIKE REQUIRED



AMSTERDAM / MONTREAL HANDHOLD 1000 mm WITH PUSHBUTTON, WITH DOOR LEAF ADJUSTMENT, ELECTRIC STRIKE REQUIRED



TEDEE SET



OPTIMA (CONFIGURATION EXAMPLE)

**TW200 BLOK
(BETA HANDLES)**

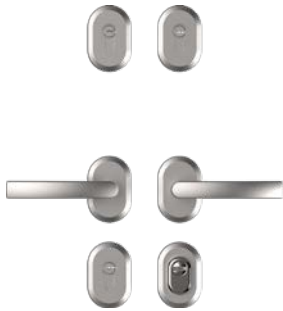

**TW200 BLOK
(BETA KNOB-HANDLE)**

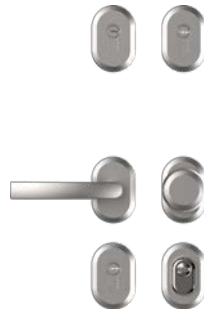

**TW300 BERGEN
(ALEX HANDLE-HANDLE)**



**TW200 BLOK
(BETA SINGLE-SIDED ON
SINGLE-SIDED), HANDHOLD**

AMSTERDAM MONTREAL

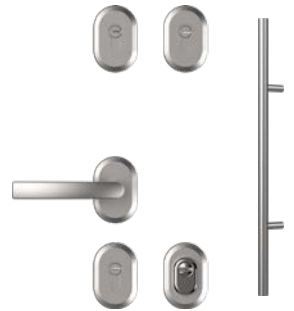

ESCUTCHEON COLORS

ANODED PLATINUM



ANODED SILVER



ANODED BLACK



OPTIMA STANDARD ACCESSORIES SET



CLASS 5 INSERTS IN ONE KEY SYSTEM

5 KEYS + INSTALLATION

MAIN LOCK ESCUTCHEON WITH PROTECTION

ADDITIONAL LOCK ESCUTCHEON WITHOUT PROTECTION

HINGE CAPS IN ESCUTCHEON COLOR

SURCHARGES

ADDITIONAL LOCK ESCUTCHEON WITH PROTECTION



KNOB-HANDLE SET



CLASS 6 THERMO PRIME INSERT



CLASS 6 LOCK INSERTS, ONE KEY SYSTEM



MAIN LOCK CLASS 2/ADDITIONAL LOCK CLASS 2 INSERT, ESCUTCHEONS WITHOUT PROTECTION (NO RC2 CLASS FOR DOOR)



AMSTERDAM / MONTREAL HANDHOLD 1500 mm, RECOMMENDED ELECTRIC STRIKE



AMSTERDAM / MONTREAL HANDHOLD 1000 mm, RECOMMENDED ELECTRIC STRIKE



AMSTERDAM / MONTREAL HANDHOLD 1500 mm WITH PUSHBUTTON, WITH DOOR LEAF ADJUSTMENT, ELECTRIC STRIKE REQUIRED



AMSTERDAM / MONTREAL HANDHOLD 1000 mm WITH PUSHBUTTON, WITH DOOR LEAF ADJUSTMENT, ELECTRIC STRIKE REQUIRED



TEDEE SET



OPTIONAL EQUIPMENT











GERDA®

DOOR SURCHARGES

	OPTIMA 50	OPTIMA 60	THERMO PREMIUM 60	THERMO PREMIUM 75	THERMO PRIME 75
ELECTRIC STRIKE WITH DAY/NIGHT FEATURE, FACTORY-FITTED IN DOOR FRAME (DOOR PRICE SURCHARGE); RECOMMENDED FOR DOORS WITH HANDHOLD; POWER SUPPLY UNIT RECOMMENDED – ADDITIONAL ACCESSORIES, P. 97	✓	✓	✓	✓	✓
ELECTRIC STRIKE WITH DAY/NIGHT FEATURE, FITTED IN ATTACHMENT, RECOMMENDED FOR DOORS WITH HANDHOLDS	-	✓	-	-	-
REED SWITCH FACTORY-FITTED IN DOOR FRAME	✓	✓	✓	✓	✓
DOOR SHORTENING WITHIN THE 0–100 RANGE (FOR SELECTED DESIGNS)	✓	✓	✓	✓	✓
TALLER DOOR; TOTAL HEIGHT UP TO 2400	-	-	-	-	2150 mm; 2200 mm; 2250 mm; 2300 mm; 2350 mm; 2400 mm
TWO-COLOR DOOR LEAF	✓	✓	✓	✓	✓
INNER DOOR LEAF REINFORCEMENT FOR SURFACE DOOR CLOSER (DOOR PRICE SURCHARGE)	✓	✓	✓	✓	✓
HIDDEN DOOR CLOSER	-	-	✓	✓	✓
DRIP EDGE (RECOMMENDED FOR INWARD OPENED DOORS)	✓	✓	✓	✓	✓
ADJUSTMENT FOR HANDHOLD WITH PUSHBUTTON	✓	✓	✓	✓	✓



HANDLES AND ESCUTCHEONS

OPTIMA 50 OPTIMA 60 THERMO PREMIUM 60 THERMO PREMIUM 75 THERMO PRIME 75

	BERGEN – DOUBLE-SIDED HANDLES ON TD200 LONG ESCUTCHEON	-	-	✓	✓	-
	BERGEN – DOUBLE-SIDED HANDLES ON TD1000 LONG ESCUTCHEON	-	-	✓	✓	-
	BERGEN – SINGLE-SIDED HANDLE ON LONG ESCUTCHEON	-	-	✓	✓	-
	BERGEN – HANDLE-KNOB ON TD200 LONG ESCUTCHEON	-	-	✓	✓	-
	BERGEN – HANDLE-KNOB ON TD1000 LONG ESCUTCHEON	-	-	✓	✓	-
	BERGEN – DOUBLE-SIDED HANDLES ON SPLIT ESCUTCHEON	✓	✓	-	-	✓
	BERGEN – SINGLE-SIDED HANDLE ON SPLIT ESCUTCHEON	✓	✓	-	-	✓
	BERGEN – HANDLE-KNOB ON SPLIT ESCUTCHEON	✓	✓	-	-	✓
	BERGEN – SPLIT ESCUTCHEON WITH TW300 KNOB PROTECTION	✓	✓	✓	✓	✓
	BERGEN – SPLIT ESCUTCHEON WITHOUT KNOB PROTECTION	✓	✓	✓	✓	✓

OPTIONAL EQUIPMENT **GERDA**[®]

HANDLES AND ESCUTCHEONS

		OPTIMA 50	OPTIMA 60	THERMO PREMIUM 60	THERMO PREMIUM 75	THERMO PRIME 75
	BLOK – DOUBLE-SIDED HANDLES ON SPLIT ESCUTCHEON	✓	✓	-	-	-
	BLOK – SINGLE-SIDED HANDLE ON SPLIT ESCUTCHEON	✓	✓	-	-	-
	BLOK – HANDLE-KNOB ON SPLIT ESCUTCHEON	✓	✓	-	-	-
	BLOK – SPLIT ESCUTCHEON WITH TW200 KNOB PROTECTION	✓	✓	-	-	-
	BLOK – SPLIT ESCUTCHEON WITH TWI000 KNOB PROTECTION	✓	✓	-	-	-
	BLOK – SPLIT ESCUTCHEON WITHOUT KNOB PROTECTION	✓	✓	-	-	-

HANDHOLDS

		OPTIMA 50	OPTIMA 60	THERMO PREMIUM 60	THERMO PREMIUM 75	THERMO PRIME 75
	AMSTERDAM RECTANGULAR HANDHOLD 1500 (CROSS SECTION 40 × 20 mm)	✓	✓	✓	✓	✓
	AMSTERDAM RECTANGULAR HANDHOLD 1000 (CROSS SECTION 40 × 20 mm)	✓	✓	✓	✓	✓
	AMSTERDAM RECTANGULAR HANDHOLD WITH PUSHBUTTON 1500 (CROSS SECTION 40 × 20 mm), PURCHASE OF ELECTRIC STRIKE REQUIRED	✓	✓	✓	✓	✓
	AMSTERDAM RECTANGULAR HANDHOLD 1000 (CROSS SECTION 40 × 20 mm), PURCHASE OF ELECTRIC STRIKE REQUIRED	✓	✓	✓	✓	✓
	MONTREAL CIRCULAR HANDHOLD 1500	✓	✓	✓	✓	✓
	MONTREAL CIRCULAR HANDHOLD 1000	✓	✓	✓	✓	✓
	MONTREAL CIRCULAR HANDHOLD WITH PUSHBUTTON 1500, PURCHASE OF ELECTRIC STRIKE REQUIRED	✓	✓	✓	✓	✓
	MONTREAL CIRCULAR HANDHOLD WITH PUSHBUTTON 1000, PURCHASE OF ELECTRIC STRIKE REQUIRED	✓	✓	✓	✓	✓

ACCESSORIES

		OPTIMA 50	OPTIMA 60	THERMO PREMIUM 60	THERMO PREMIUM 75	THERMO PRIME 75
	WIDE-ANGLE VIEWER 50/80	✓	✓	✓	✓	✓
	ELECTRONIC VIEWER 4.3"	✓	✓	✓	✓	✓
	ELECTRONIC VIEWER 2,4"	✓	✓	✓	✓	✓
	ACCESS CONTROL NUMERIC KEYPAD	✓	✓	✓	✓	✓
	BUFFER POWER SUPPLY UNIT AWZG2-12V; RECOMMENDED FOR DOORS WITH ELECTRIC STRIKE	✓	✓	✓	✓	✓
	SWITCHING POWER SUPPLY PSC12015; RECOMMENDED FOR DOORS WITH ELECTRIC STRIKE	✓	✓	✓	✓	✓
	LOWER LOCKING PLATE	✓	✓	-	-	-
	HIDDEN DOOR CLOSER	-	-	✓	✓	✓
	DOOR CLOSER GT 1500 STANDARD	✓	✓	✓	✓	✓
	DOOR CLOSER GT 1500 INTERLOCK	✓	✓	✓	✓	✓
	ALUMINUM DECORATIVE CAPS FOR HINGES	✓	✓	✓	✓	✓
	ALUMINUM SILL 20 mm	✓	✓	-	-	-
	WARM ALUMINUM SILL 20 mm	-	-	✓	✓	✓
	WARM PCV SILL 20 mm	-	-	✓	✓	-
	WOODEN SILL 19 mm	✓	✓	-	-	-
	DRIP EDGE IN DOOR COLOR	✓	✓	✓	✓	✓

OPTIONAL EQUIPMENT



ACCESSORIES

		OPTIMA 50	OPTIMA 60	THERMO PREMIUM 60	THERMO PREMIUM 75	THERMO PRIME 75
	STEEL-WOODEN SIDE EXTENSION 30 mm (FOR PERFOTHERM, DUOTHERM DOOR FRAMES)	✓	✓	✓	✓	-
	STEEL-WOODEN SIDE EXTENSION 60 mm (FOR PERFOTHERM, DUOTHERM DOOR FRAMES)	✓	✓	✓	✓	-
	ALUMINUM SIDE EXTENSION 28 mm (FOR ALUTHERM DOOR FRAME AND ALUMINUM ILLUMINATOR)	-	✓	✓	✓	-
	ALUMINUM SIDE EXTENSION 52 mm (FOR ALUTHERM DOOR FRAME AND ALUMINUM ILLUMINATOR)	-	✓	✓	✓	-
	ALUMINUM SIDE EXTENSION 114 mm (FOR ALUTHERM DOOR FRAME AND ALUMINUM ILLUMINATOR)	-	✓	✓	✓	-
	ALUMINUM SIDE EXTENSION 25 mm (FOR ALUTHERM PRIME DOOR FRAME)	-	-	-	-	✓
	ALUMINUM SIDE EXTENSION 33 mm (FOR ALUTHERM PRIME DOOR FRAME)	-	-	-	-	✓
	ALUMINUM SIDE EXTENSION 44 mm (FOR ALUTHERM PRIME DOOR FRAME)	-	-	-	-	✓
	ALUMINUM SIDE EXTENSION 55 mm (FOR ALUTHERM PRIME DOOR FRAME)	-	-	-	-	✓
	ALUMINUM SIDE EXTENSION 108 mm (FOR ALUTHERM PRIME DOOR FRAME)	-	-	-	-	✓
	UNDER SILL EXTENSION 30 mm (MB)	✓	✓	✓	✓	-
	SUB SILLS (EXTENSIONS) OF HARDENED EXPANDED POLYSTYRENE. (THERMO PRIME)	-	-	-	-	
						70 mm, 100 mm, 130 mm, 160 mm, 190 mm, 220 mm, 250 mm
	DOOR MAINTENANCE AGENT	✓	✓	✓	✓	✓
	LOCKS AND INSERTS MAINTENANCE AGENT 25 ML	✓	✓	✓	✓	✓
	LOCKS AND INSERTS MAINTENANCE AGENT 100 ML	✓	✓	✓	✓	✓
	LOCKS AND INSERTS MAINTENANCE AGENT 400 ML	✓	✓	✓	✓	✓
	GERDA INOX-1, INOX-2 STAINLESS STEEL CLEANING AGENTS SET	✓	✓	✓	✓	✓
	GERDA RESIST ULTRA DUO TAPES FOR WARM INSTALLATION	✓	✓	✓	✓	✓

OPTIMA 50 RC2

SIZE	MAIN LOCK	ADDITIONAL LOCK	NUMBER OF KEYS	INSERT CLASS
30/45	DRIVER	-	5	2
30/45 ; 45/30	-	DRIVER	5	2
30/45 ; 45/30	DRIVER	DRIVER	5+INSTALLATION	5
30/45 ; 45/30	DRIVER	DRIVER	5+INSTALLATION	6

OPTIMA 60 RC2

SIZE	MAIN LOCK	ADDITIONAL LOCK	NUMBER OF KEYS	INSERT CLASS
35/50	DRIVER	-	5	2
35/50 ; 50/35	-	DRIVER	5	2
35/50 ; 50/35	DRIVER	DRIVER	5+INSTALLATION	5
35/50 ; 50/35	DRIVER	DRIVER	5+INSTALLATION	6

OPTIMA 60 RC3

SIZE	MAIN LOCK	ADDITIONAL LOCK	NUMBER OF KEYS	INSERT CLASS
35/50 ; 50/35	GEAR	DRIVER	5+INSTALLATION	5
35/50 ; 50/35	GEAR	DRIVER	5+INSTALLATION	6

THERMO PREMIUM 60 RC2

SIZE	MAIN LOCK	ADDITIONAL LOCK	NUMBER OF KEYS	INSERT CLASS
35/50	DRIVER	-	5+INSTALLATION	5
35/50 ; 50/35	-	DRIVER	5	2
35/50 ; 50/35	DRIVER	DRIVER	5+INSTALLATION	5
35/50 ; 50/35	DRIVER	DRIVER	5+INSTALLATION	6

THERMO PREMIUM 60 RC3

SIZE	MAIN LOCK	ADDITIONAL LOCK	NUMBER OF KEYS	INSERT CLASS
35/50	GEAR	-	5+INSTALLATION	5
35/50 ; 50/35	-	DRIVER	5	2
35/50 ; 50/35	GEAR	DRIVER	5+INSTALLATION	5
35/50 ; 50/35	GEAR	DRIVER	5+INSTALLATION	6

THERMO PREMIUM 75 RC2/RC3

SIZE	MAIN LOCK	ADDITIONAL LOCK	NUMBER OF KEYS	INSERT CLASS
45/55	GEAR	-	5+INSTALLATION	5
45/55 ; 55/45	-	DRIVER	5	2
45/55 ; 55/45	GEAR	DRIVER	5+INSTALLATION	5
45/55 ; 55/45	GEAR	DRIVER	5+INSTALLATION	6

THERMO PRIME 75 RC2/RC3

SIZE	MAIN LOCK	ADDITIONAL LOCK	NUMBER OF KEYS	INSERT CLASS
55/45	DRIVER	HANDLE / HANDLE INWARDS	5+INSTALLATION	5
55/35	DRIVER	HANDLE / HANDHOLD INWARDS	5+INSTALLATION	5
45/50	DRIVER	HANDLE / HANDLE OUTSIDE	5+INSTALLATION	5
G50/50	DRIVER	HANDLE / HANDLE OUTSIDE	5+INSTALLATION	5
45/35	DRIVER	HANDLE / HANDHOLD OUTSIDE	5+INSTALLATION	5
G50/35	DRIVER	HANDLE / HANDHOLD OUTSIDE	5+INSTALLATION	5

DOUBLE LOCK DOORS: MAIN LOCK – KEY/KEY INSERT; ADDITIONAL LOCK – KEY/KNOB INSERT.
SINGLE LOCK DOORS: MAIN LOCK – KEY/KEY OR KEY/KNOB INSERT

DOOR AND DOOR FRAME DIMENSIONS



THERMO PRIME DOORS / THERMO PREMIUM LEAF SIZE [mm]

WIDTH

SIZE	DOOR MODEL	DOOR LEAF WIDTH, NARROW SIDE (Sp)	DOOR LEAF WIDTH, BROAD SIDE (Ss)
80	THERMO PRIME / THERMO PREMIUM	812	842
90N		882	912
90E		925	955
100E		1025	1055

HEIGHT

DOOR MODEL	HEIGHT	DOOR LEAF HEIGHT, NARROW SIDE (Hs)	DOOR LEAF HEIGHT, BROAD SIDE (Hp)
T. PRIME / T.PREMIUM	2087	2009	2039
THERMO PRIME	2100	2022	2052
	2150	2072	2102
	2200	2122	2152
	2250	2172	2202
	2300	2222	2252
	2350	2272	2302
	2400	2322	2352

ALUTHERM PRIME / ALUTHERM PREMIUM / DUOTHERM DOOR FRAME SIZE [mm]

SIZE	DOOR FRAME MODEL	TOTAL DOOR FRAME WIDTH (Sc)	RECOMMENDED MOUNTING CUT-OUT WIDTH (Sm)*	TOTAL DOOR FRAME HEIGHT (Hc)	RECOMMENDED MOUNTING CUT-OUT HEIGHT FROM "0" (Hm)
80	DUOTHERM	896	916	2076	2086
90 N		966	986		
90 E		1009	1029		
100 E		1109	1129		
80	ALUTHERM	918	938	STANDARD 2087 CUSTOM**	STANDARD 2097 CUSTOM**
90 N		988	1008		
90 E		1031	1051		
100 E		1131	1151		

* INCLUDES 10 mm INSTALLATION PLAY

** THERMO PRIME ONLY

GERDA® DOOR AND DOOR FRAME DIMENSIONS

THERMO PRIME 75 / THERMO PREMIUM 75

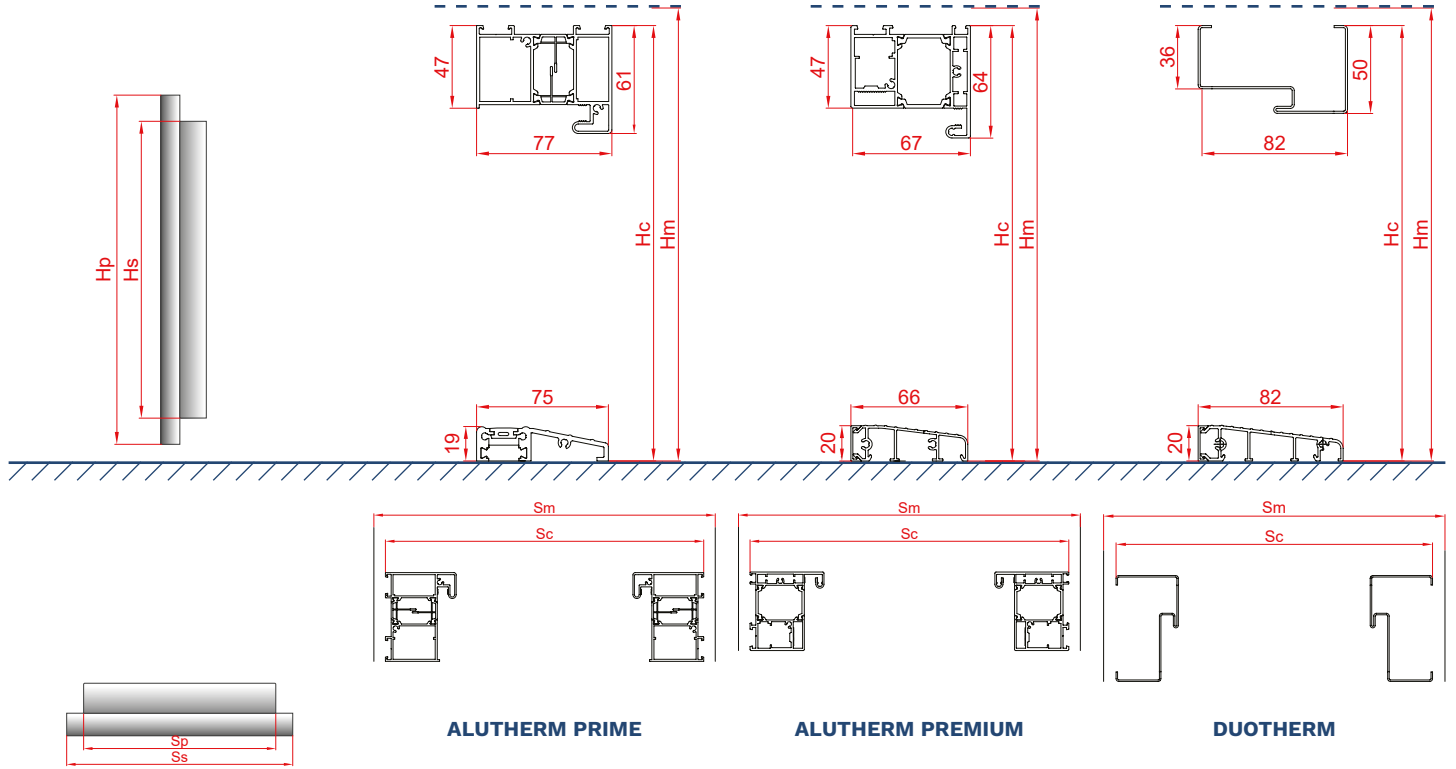

THERMO PREMIUM 60

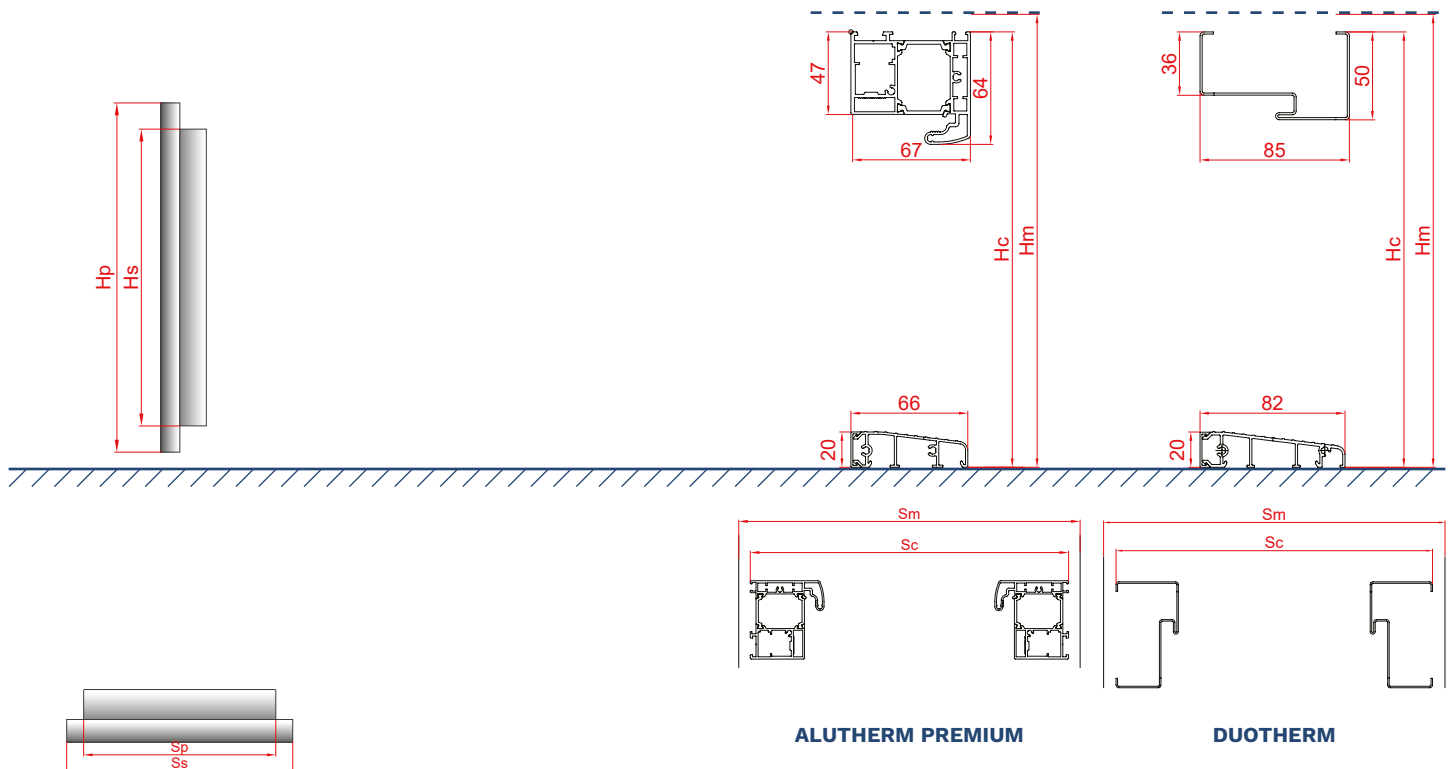

* AVOID INSTALLING DARK COLOR DOORS IN AREAS EXPOSED TO DIRECT AND LONG-TERM SUNLIGHT. DOOR INSTALLED AS EXTERIOR ENTRANCE DOOR AT SITES DIRECTLY EXPOSED TO WEATHER CONDITIONS (RAIN, WIND, ETC.) SHOULD OPEN OUTWARDS. IF MOUNTED AS AN EXTERIOR ENTRANCE DOOR, A ROOFING IS REQUIRED.

DOOR AND DOOR FRAME DIMENSIONS



OPTIMA DOORS LEAF SIZE [mm]

SIZE	MODEL DRZWI	DOOR LEAF WIDTH, NARROW SIDE (Sp)	DOOR LEAF WIDTH, BROAD SIDE (Ss)	DOOR LEAF HEIGHT, NARROW SIDE (Hs)	DOOR LEAF HEIGHT, BROAD SIDE (Hp)
80N	OPTIMA	782	812	2023	2038,5
80		812	842		
90N		882	912		
90E		925	955		
100E		1025	1055		
30	OPTIMA DUO 60	257	287		
40		357	387		
50		457	487		

ALUTHERM OPTIMA, PERFOTHERM, FB FRAME SIZE [mm]

SIZE	DOOR FRAME MODEL	TOTAL DOOR FRAME WIDTH (Sc)	RECOMMENDED MOUNTING CUT-OUT WIDTH (Sm)*	TOTAL DOOR FRAME HEIGHT (Hc)	RECOMMENDED MOUNTING CUT-OUT HEIGHT FROM "0" (Hm)
80N	PERFOTHERM, FB	866	886	2076	2086
80		896	916		
90 N		966	986		
90 E		1009	1029		
100 E		1109	1129		
80	ALUTHERM	918	938	2087	2097
90 N		988	1008		
90 E		1031	1051		
100 E		1131	1151		

* INCLUDES 10 mm INSTALLATION PLAY

GERDA® DOOR AND DOOR FRAME DIMENSIONS

OPTIMA 60

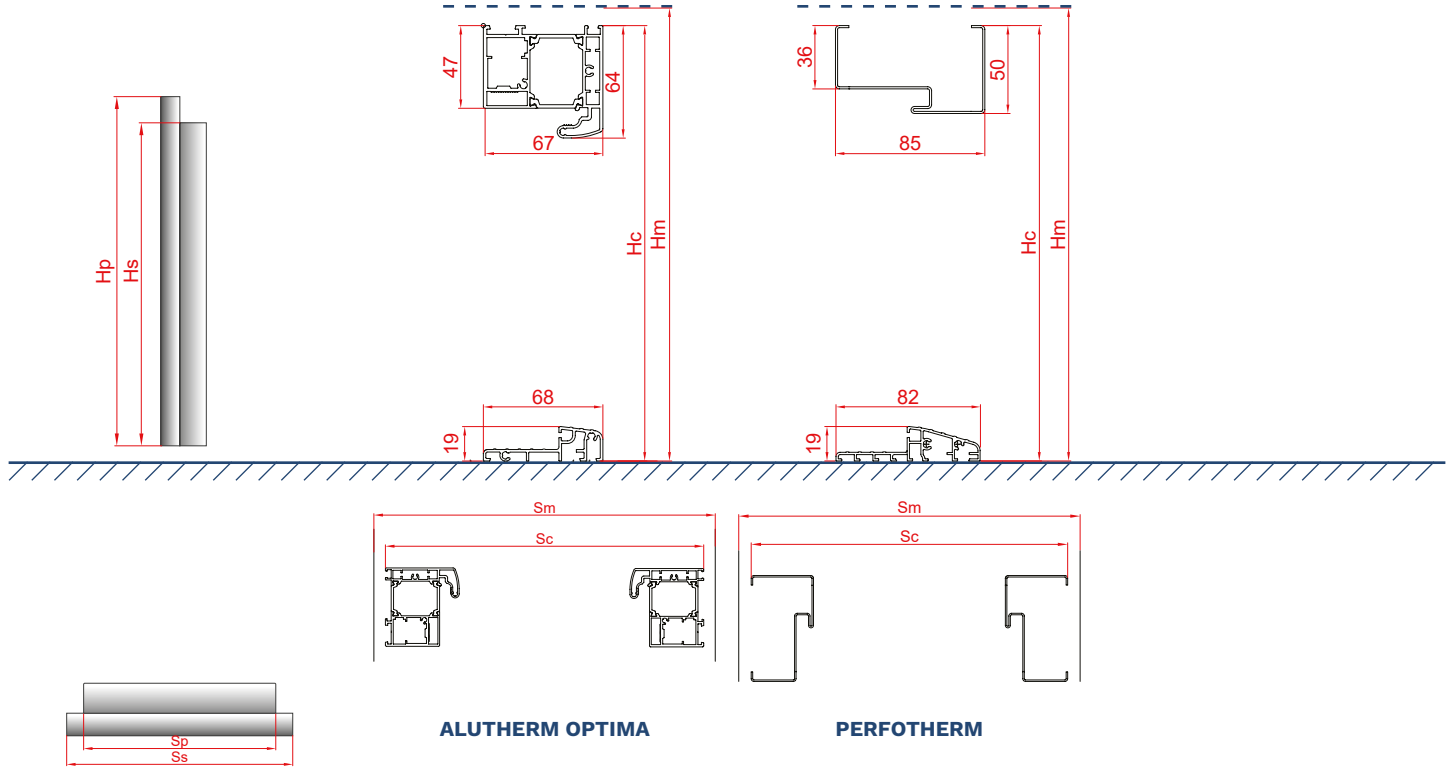

OPTIMA 50

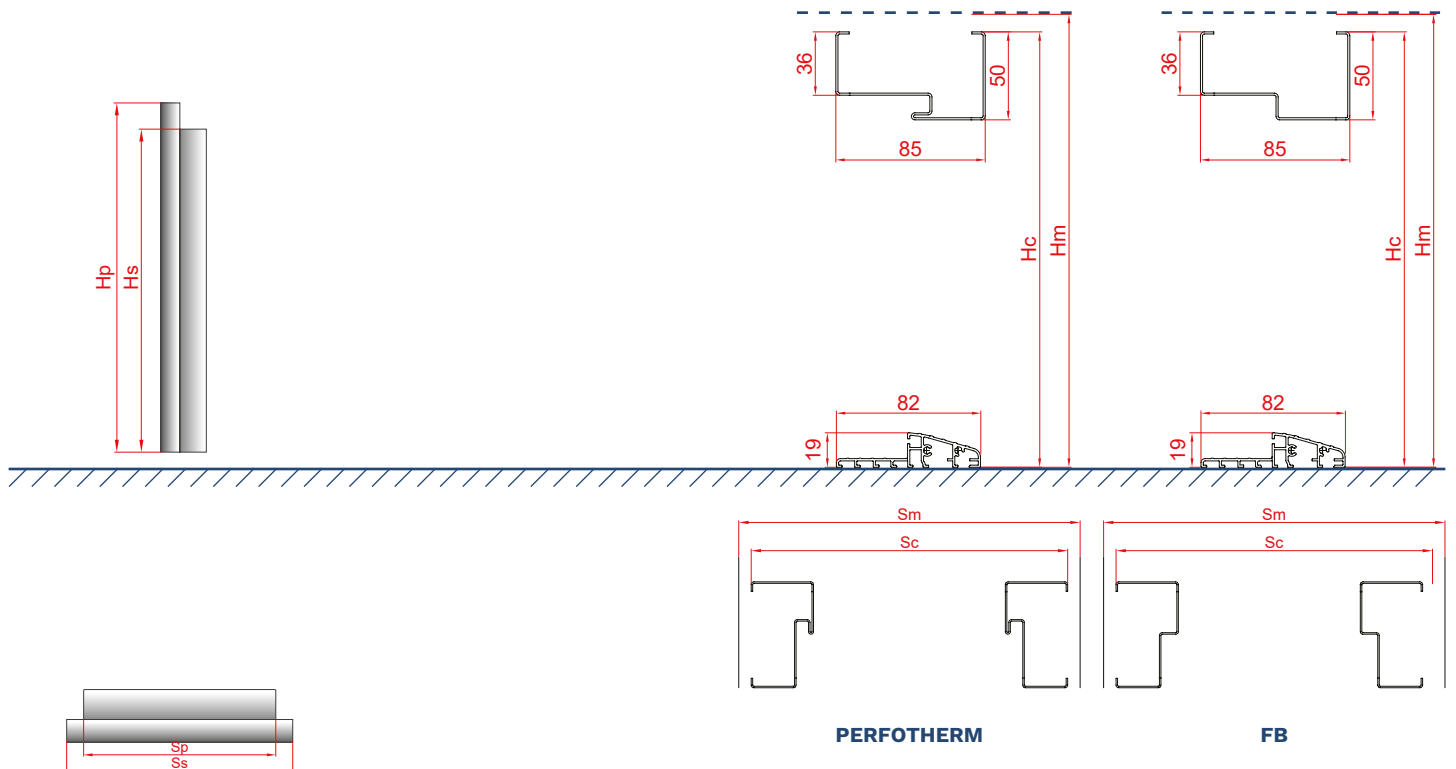

* AVOID INSTALLING DARK COLOR DOORS IN AREAS EXPOSED TO DIRECT AND LONG-TERM SUNLIGHT. DOOR INSTALLED AS EXTERIOR ENTRANCE DOOR AT SITES DIRECTLY EXPOSED TO WEATHER CONDITIONS (RAIN, WIND, ETC.) SHOULD OPEN OUTWARDS. IF MOUNTED AS AN EXTERIOR ENTRANCE DOOR, A ROOFING IS REQUIRED.

DOOR AND DOOR FRAME DIMENSIONS



FN DOOR FRAME SIZE FOR OPTIMA DOOR [mm]

SIZE	DOOR FRAME MODEL	TOTAL DOOR FRAME WIDTH (Sc1)	TOTAL DOOR FRAME WIDTH (Sc2)	RECOMMENDED MOUNTING CUT-OUT WIDTH (Sm)	TOTAL DOOR FRAME HEIGHT (Hc1)	TOTAL DOOR FRAME HEIGHT (Hc2)	RECOMMENDED MOUNTING CUT-OUT HEIGHT FROM "0" (Hm)
80N	FN	862	797	817	2075	2041	2051
80		892	827	847			
90N		962	897	917			
90E		1005	940	960			
100E		1105	1040	1060			

ALUTHERM OPTIMA, PERFOTHERM DOOR FRAME SIZE FOR OPTIMA DUO 60 DOORS [mm]

SIZE	ALUTHERM		PERFOTHERM		ALUTHERM		PERFOTHERM	
	TOTAL DOOR FRAME WIDTH (Sc)	RECOMMENDED MOUNTING CUT-OUT WIDTH (Sm)	TOTAL DOOR FRAME WIDTH (Sc)	RECOMMENDED MOUNTING CUT-OUT WIDTH (Sm)*	TOTAL DOOR FRAME HEIGHT (Hc)	RECOMMENDED MOUNTING CUT-OUT HEIGHT FROM "0" (Hm)	TOTAL DOOR FRAME HEIGHT (Hc)	RECOMMENDED MOUNTING CUT-OUT HEIGHT FROM "0" (Hm)
80	918	938	896	916	2087	2097	2076	2086
80+30	1209	1229	1187	1207				
80+40	1309	1329	1287	1307				
80+50	1409	1429	1387	1407				
90 E	1031	1051	1009	1029				
90 E +30	1322	1342	1300	1320				
90 E +40	1422	1442	1400	1420				
90 E +50	1522	1542	1500	1520				
100 E	1131	1151	1109	1129				
100 E +30	1422	1442	1400	1420				
100 E +40	1522	1542	1500	1520				
100 E +50	1622	1642	1600	1620				

* INCLUDES 10 mm INSTALLATION PLAY

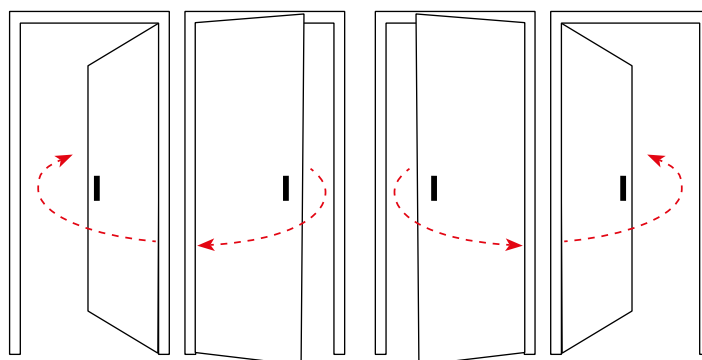

LEFT-HAND DOOR

RIGHT-HAND DOOR

GERDA® DOOR AND DOOR FRAME DIMENSIONS

OPTIMA 50

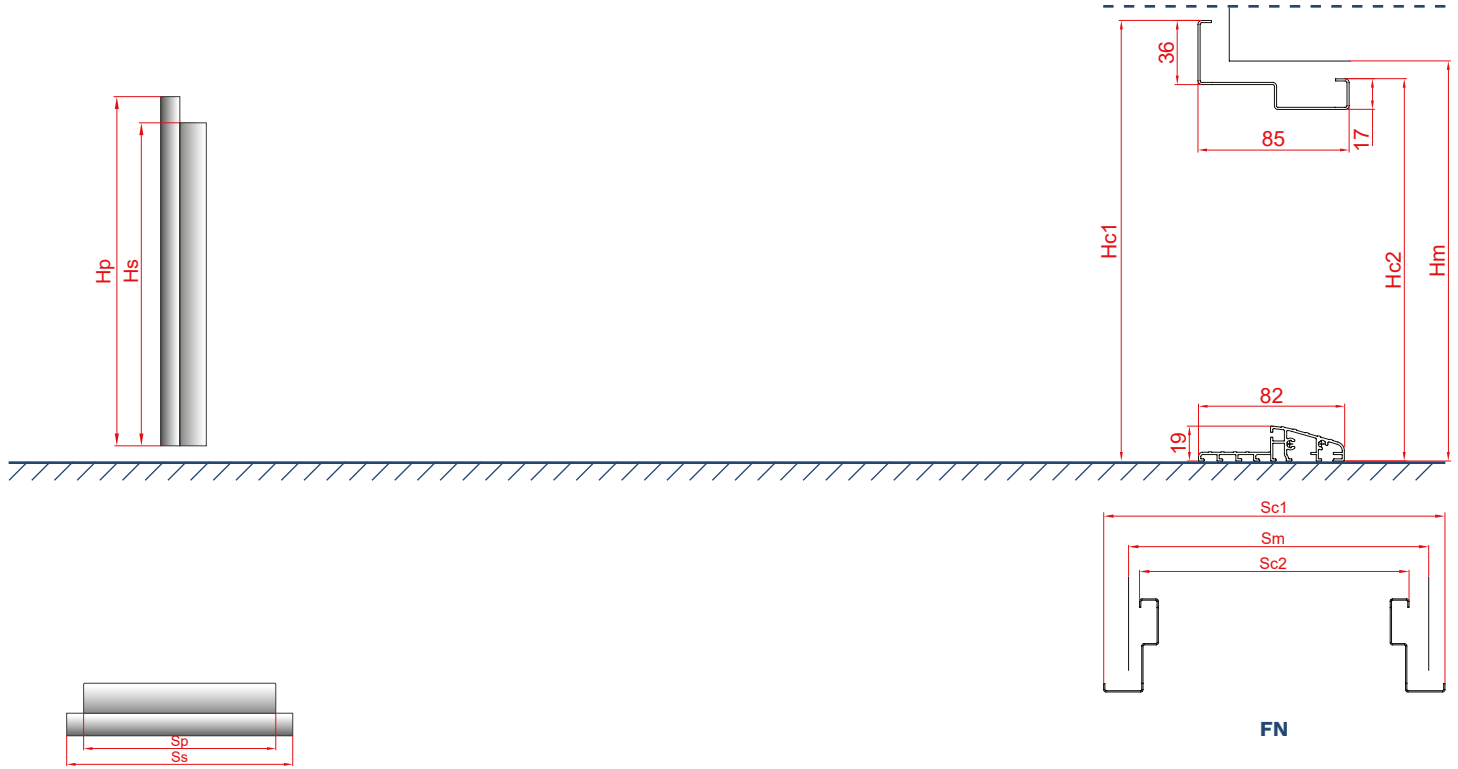

DUO

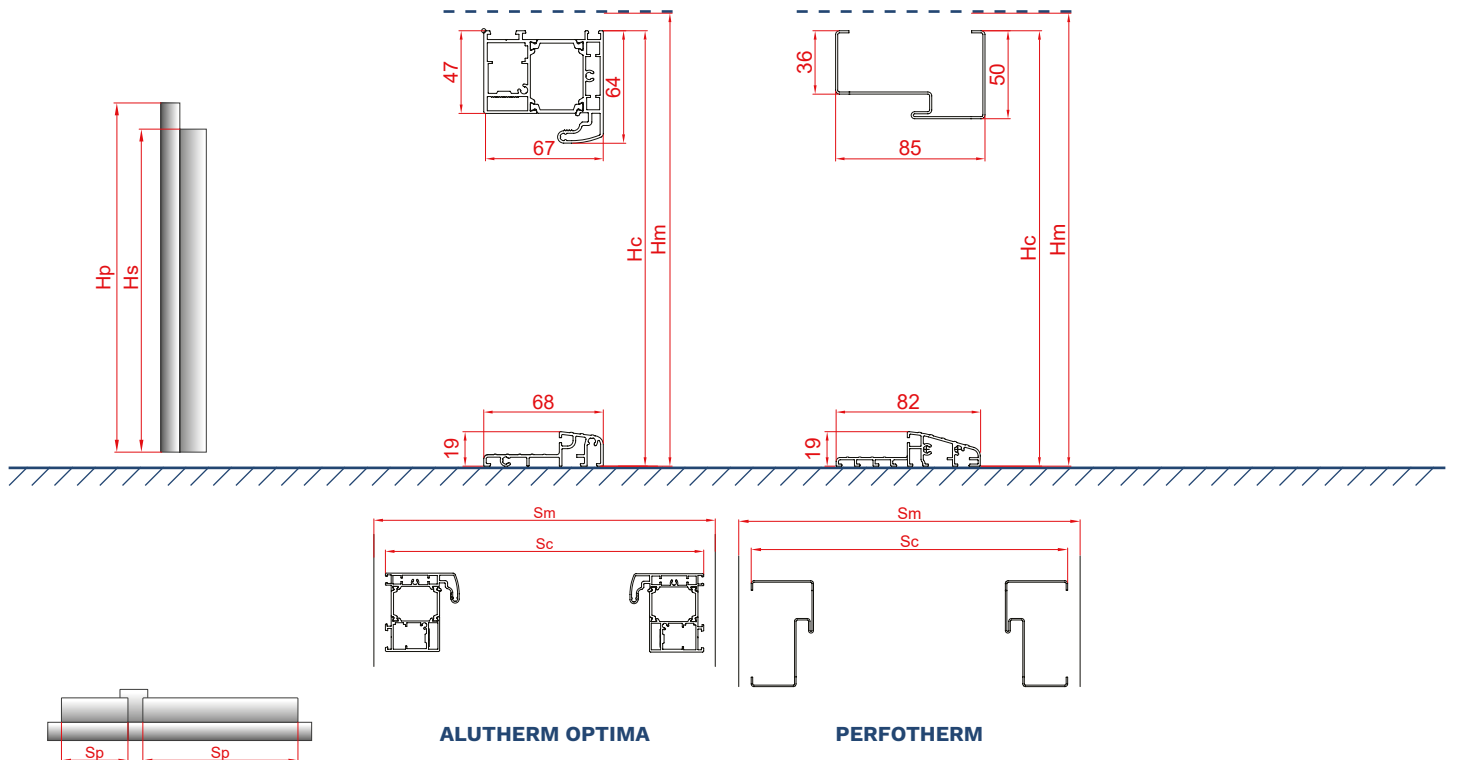

* AVOID INSTALLING DARK COLOR DOORS IN AREAS EXPOSED TO DIRECT AND LONG-TERM SUNLIGHT. DOOR INSTALLED AS EXTERIOR ENTRANCE DOOR AT SITES DIRECTLY EXPOSED TO WEATHER CONDITIONS (RAIN, WIND, ETC.) SHOULD OPEN OUTWARDS. IF MOUNTED AS AN EXTERIOR ENTRANCE DOOR, A ROOFING IS REQUIRED.

INSPIRATIONS HIDDEN IN COMPLETED PROJECTS



GERDA[®] INSPIRATIONS HIDDEN IN COMPLETED PROJECTS





Gerda Sp. z o.o.

Sokołów, ul. Sokołowska 49

05-806 Komorów

Tel.: (+48 22) 329 10 30

www.gerda.pl

Distributor:

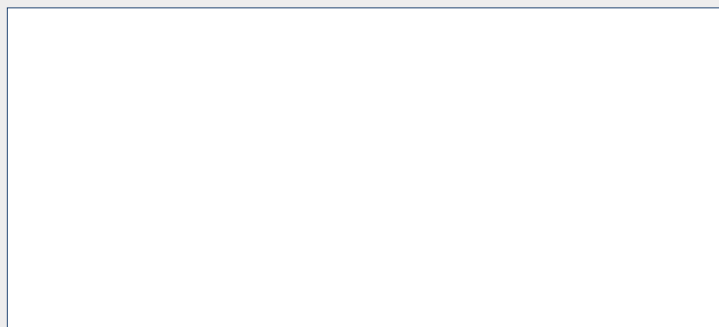

This catalogue does not constitute an offer under the provisions of law and is merely informational.

Gerda, committed to continuously improving its products and services, reserves the right (without prior notice) to introduce changes to products that, due to the printing material preparation process, may not be included in this material.

Despite all the effort and care in controlling the presented content, substantial or printing errors may occur.

Colors presented herein may differ from the original due to different color reproduction technique in the printing process. The owner of the copyright for this catalogue, as well as Gerda logotypes and graphics, is Gerda Sp. z o.o.

It is prohibited to copy or distribute any content and material without the prior consent of Gerda Sp. z o.o.